



WENZHOU RUNXIN MANUFACTURING MACHINE CO.,LTD

ADD: Jinger Road, Shatou Group, Linjiang, Lucheng District, Wenzhou, Zhejiang, China
Tel: +86-577-88635628 88630038 Fax: +86-0577-88633258
Http://www.run-xin.com Email:sales@run-xin.com



International Patent Public No.:WO 2006/007772
China Patent No.: ZL02220153.X,
ZL200420062895.3
US Patent No.: 7549446
India Patent No.: 232582
Russia Patent No.: 2349819
South Korea Patent No.: 10-0914137
Mexico Patent No.: 268581
Australia Patent No.: 2005263257
Philippine Patent No.: 1-2006-502553
Taiwan Patent No.: M287896

Multi-functional Flow Control Valve for Water Treatment Systems

53520 (F111B1)
53620 (F111B3)
63520 (F111A1)
63620 (F111A3)

User Manual

Please read this manual in details before using the valve and
keep it properly in order to consult in the future.

OWRX.466.583

Before the valve put into use, please fill in the below content so as to help us to refer in the future .

Softener System Configuration

Tank Size: Dia. _____ mm, Height _____ mm;

Resin Volume _____ L; Brine Tank Capacity _____ L;

Hardness of Raw Water _____ mmol/L;

Pressure of Inlet Water _____ MPa;

Control Valve Model _____ ; Number _____ ;

The Specification of Drain Line Flow Control _____ ;

The Specification of Brine Line Flow Control _____ ;

Injector No. _____ .

Water Source: Ground-water Filtered Ground-water Tap Water
Other _____ .

Parameter Set

Parameter	Unit	Factory Default	Actual Value
Control Mode A-01/02/03/04 (Meter type) F111B only has A-01/02	/	A-01	
Water Treatment Capacity (Meter type)	m ³	200.0	
Service Days (Time clock type, by days)	D.	03	
Regeneration Time	/	02 : 00	
Backwash Time (F111A/B has)	min:sec	10 : 00	
Brine & Slow Rinse Time (F111A has)	min:sec	60 : 00	
Brine Refill Time (F111A has)	min:sec	05 : 00	
Fast Rinse Time (F111A/B has)	min:sec	10 : 00	
Interval Regeneration Days (Meter type has)	D.	30	
Output Mode b-01/2	/	b-01	

● If there is no special requirement when product purchase, we choose 4# drain line flow control (With 3 holes of $\phi 6$) and 4# injector (7704) for the standard configuration for 63620/63520.

Catalogue

Notice	1
1.Product Overview	2
1.1.Main Application & Applicability	2
1.2.Product Characteristics	2
1.3.Service Condition	5
1.4.Product Structure and Technical Parameters	5
1.5.Installation	6
2.Basic Setting & Usage	10
2.1.The Function of PC Board	10
2.2.Basic Setting & Usage	11
3.Applications	15
3.1.Flow Chart	15
3.2.The Function and Connection of PC Board	16
A.Signal Output Connector	17
B.Interlock	20
C.Pressure Relief Output	20
D.Remote Handling Connector	20
E.Interlock System	21
F.Series System	21
3.3.System Configuration and Flow Rate Curve	21
3.4.Parameter Settlement	24
3.5.Parameter Enquiry and Setting	25
3.6.Trial Running	29
3.7.Trouble-shooting	30
3.8.Assembly & Parts	34
4.Warranty Card	37

Notice

- To ensure normal operation of the valve, please consult with professional installation or repairing personnel before use it.
- If there are any of pipeline engineering and electric works, there must be finished by professional at the time of installation.
- Do not use the control valve with the water that is unsafe or unknown quality.
- Depending on the changing of working environment and water requirement, each parameter of softener should be adjusted accordingly.
- When the water treatment capacity is too low, please check the resin. If the reason is shortage of resin, please add; if the resin turns reddish brown or broken, please replace.
- Test water periodically to verify that system is performing satisfactorily.
- Ensure that there is solid salt all the time in the brine tank in the course of using, when this valve is used for softening. The brine tank should be added the clean water softening salts only, at least 99.5% pure, forbidding use the small salt.
- Do not put the valve near the hot resource, high humidity, corrosive, intense magnetic field or intense vibrations environment. And do not leave it outside.
- Forbidden to carry the injector body. Avoid to use injector body as support to carry the system.
- Forbidden to use the brine tube or other connectors as support to carry the system.
- Please use this product under the water temperature between 5~50℃, water pressure 0.2~0.6MPa. Failure to use this product under such conditions voids the warranty.
- If the water pressure exceeds 0.6Mpa, a pressure reducing valve must be installed before the water inlet. While, if the water pressure under 0.2MPa, a booster pump must be installed before the water inlet.
- It is suggested to install PPR pipe, corrugated pipe or UPVC pipe, instead of TTLSG pipe. Keep the pipeline straight.
- Do not let children touch or play, because carelessness operating may cause the procedure changed.
- When the attached cables of this product and transformer are broken, they must be changed to the one that is from our factory.

1. Product Overview

1.1. Main Application & Applicability

Used for softening, demineralization or filtration water treatment systems

● 53520/53620 (Filtration)

Suitable for swimming pool filter system

Filtration system

Activated carbon filter or sand filter of RO pretreatment system.

● 63520/63620 (Down-flow regeneration)

Suitable for ion exchange equipment, the raw water hardness ≤ 6.5 mmol/L.

Boiler softening water system

RO pretreatment softening system, etc.

1.2. Product Characteristics

● Simple structure and reliable sealing

It adopts hermetic head faces with high degree pottery and corrosion resistance for opening and closing. It combines with Service, Backwash, Brine & Slow Rinse, Brine Refill and Fast Rinse.

● No water passes the valve during regeneration in single tank type

● Brine refill controlled by electronic ball valve

During service, electronic ball valve will control to start the brine refill. In order to short the regeneration cycle time.

● DF softener system can be changed to filtration system

Block the brine line connector and remove the drain connector of 63520 to change the valve to filter valve 53520.

Block the brine line connector and remove the drain connector of 63620 to change the valve to filter valve 53620.

● Manual function

Realize regeneration immediately by pushing “” at any time.



● Long outage indicator

If outage overrides 3 days, the time of day indicator “12:12” will flash to remind people to reset new time of day. The other set parameters do not need to reset. The process will continue to work after power on.





● LED dynamic screen display

The stripes on dynamic screen flash, they indicate the control valve is in service, otherwise, it is in regeneration cycle.

● Buttons lock

No operations to buttons on the controller within 1 minute, button lock indicator light on which represent buttons are locked. Before operation, press and hold the “” and “” buttons for 5 seconds to unlock. This function can avoid incorrect operation.

● It can choose all models by program selection

When all symbols light on, press and hold “” and “” buttons more than 2 seconds to enter the menu of valve model selection. Press “” and “” buttons to select the requested model, then press “” button to save the selection. Reconnect the power, the model will be showed on display board.

● Interlock function

It has a function of interlock to realize only one valve in regeneration but the other valves are in service while several valves parallel in system. In multi-steps treatment systems such as RO pre-treatment, when several valves are in series, there is only one valve in regeneration or washing to ensure pass water all the times. (Application refer to Figure 3-9)

● Signal output (Only for 63620/63520)

There is a signal output connector on main control board. It is for controlling external wiring (Refer to Figure 3-1 to Figure 3-8).

There are two kinds of output modes: b-01 Mode: Turn on start of regeneration and shut off end of regeneration; b-02 Mode: Signal available only intervals of each status.

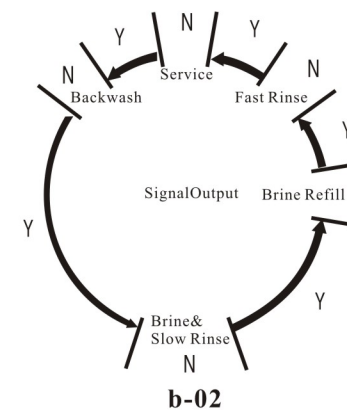
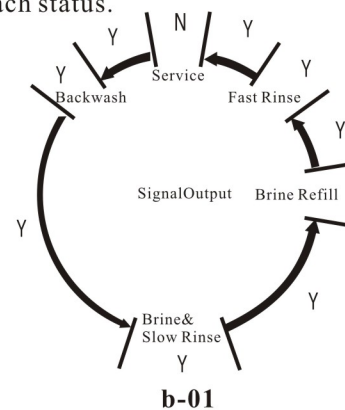

●Remote handling input

This connector can receive external signal, used together with PLC, and computer etc. to control the valve. (Application refers to Figure3-11)

●Pressure relief output

The valve will cut off feeding water to drain line when it switches in regeneration cycles (Same as signal output b-02). Thus in some water treatment system, e.g. Deep Well, one booster pump was installed on the inlet to increase the system water feeding pressure, this cut-off will cause pressure on inlet rising too fast to damage the valve. Pressure Relief Output can be used to avoid this problem. (Application refers to Figure3-10)

●All parameters can be modified

According to the water quality and usage, the parameters in the process can be adjusted.

●Four kinds of meter type can be selected (Suit for 63620)

Mode	Name	Instruction
A-01	Meter Delayed	Regenerate on the day although the available volume of treated water drops to zero (0). Regeneration or fast rinse starts at the regeneration time.
A-02	Meter Immediate	Regenerate or fast rinse immediately when the available volume of treated water drops to zero(0).
A-03	Intelligent Meter Delayed	Meter Delayed Regeneration type, but by setting Resin Volume, Feed Water Hardness, Regeneration Factor, the controller will calculate the System Capacity. Regeneration mode is the same as A-01.
A-04	Intelligent Meter Immediate	Meter Immediately Regeneration Type, but by setting Resin Volume, Feed Water Hardness, Regeneration Factor, the controller will calculate the System Capacity. Regeneration mode is the same as A-02.

A-01, A-02 are suitable for 53620.

●Maximum interval regeneration days (Suit for 53620/63620)

Under the situation of service reaching the setting days and the volume not yet, it could enter into regeneration process or fast rinse forcibly when current time is the same as regeneration time.

1.3.Service Condition

Runxin Valve should be used under the below conditions:

Items		Requirement
Working conditions	Water pressure	0.2MPa ~ 0.6MPa
	Water temperature	5°C~50°C
Working environment	Environment temperature	5°C~50°C
	Relative humidity	≤95% (25°C)
	Electrical facility	AC100~240V/50~60Hz
Inlet water quality	Water turbidity	Softener(63520/63620) < 5FTU; Filter(53520/53620) < 20FTU
	Water hardness	First Grade Na ⁺ <6.5mmol/L; Second Grade Na ⁺ <10mmol/L
	Free chlorine	<0.1mg/L
	Iron ²⁺	<0.3mg/L
	CODMn	<2mg/L (O ₂)

In the above table, First Grade Na⁺ represents First Grade Na⁺ Exchanger. Second Grade Na⁺ represents Second Grade Na⁺ Exchanger.

●When the water turbidity exceeds the conditions, a filter should be installed on the inlet of control valve.

●When the water hardness exceeds the conditions, the outlet water hardness will hardly reach the requirement of boiler feed water(0.03 mmol/L). It is suggested to adopt second grade softener.

1.4.Product Structure and Technical Parameters

A. Product dimension (The appearance is just for reference. It is subjected to the real product.)

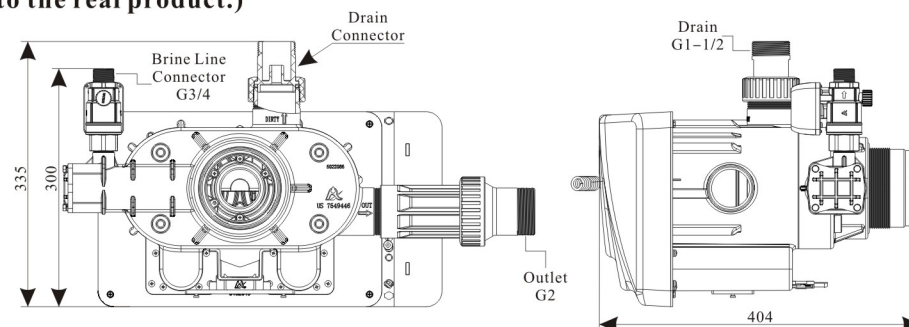

Structure of 63620

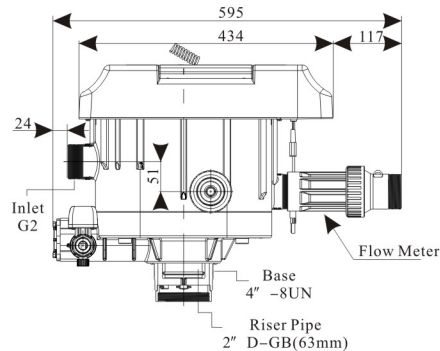

Structure of 63620

Remark:

Remove the flow meter from 63620, it will be 63520.

If block the brine line connector of 63620 and remove the ball valve and drain connector, it will be 53620.

If block the brine line connector of 63520 and remove the ball valve and drain connector, it will be 53520.

B. Technical parameter

Transformer Output: DC24V/1.5A

Model	Connector Size				Flow Rate m ³ /h@ 0.2MPa	Remark
	Inlet/ Outlet	Drain	Brine Line Connector	Base		
53620	2" M	2" M	/	4" -8UN	See the Flow Rate Characteristic	Filter, meter type
53520						Filter, time clock type
63620	2" M	1.5" M	3/4" M	4" -8UN	21.1	DF softener, meter type
63520						DF softener, time clock type

Remark: M—Male F—Female

1.5.Installation

A. Installation notice

Before installation, read all those instructions completely. Then obtain all materials and tools needed for installation.

The installation of product, pipes and circuits, should be accomplished by professional to ensure the product can operate normally.

Perform installation according to the relative pipeline regulations and the specification of Water Inlet, Water Outlet, Drain Outlet, and Brine Line Connector.

B. Device location

- ① The filter or softener should be located close to drain.
- ② Ensure the unit is installed in enough space for operating and maintenance.
- ③ Brine tank need to be close to softener.
- ④ The unit should be kept away the heater, and not be exposed outdoor. Sunshine or rain will cause the system damage.
- ⑤ Please avoid to install the system in one acid/alkaline, magnetic or strong vibration circumstance, because above factors will cause the system disorder.
- ⑥ Do not install the filter or softener, drain pipeline in circumstance which temperature may drop below 5℃, or above 45℃.
- ⑦ One place is recommended to install the system which cause the minimum loss in case of water leaking.

C. Pipeline installation (Take 63620 as a sample)

- ① Install control valve
 - a. As the Figure 1-1 shows, select the riser pipe with 63mm OD, glue the riser pipe to the bottom strainer and put it into the mineral tank, cut off the exceeding tube out of tank top opening. Plug the riser tube in case of mineral entering.
 - b. Fill the mineral to the tank, and the height is accordance with the design code.
 - c. Install the top distributor to the valve.
 - d. Insert the riser tube into control valve and screw tight control valve.

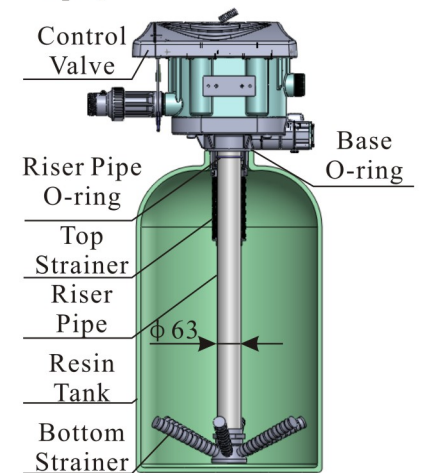

Figure 1-1

Note:

- The length of riser tube should be neither higher 2 mm nor lower 5 mm tank top opening height, and its top end should be rounded to avoid damage of O-ring inside the valve.
- Avoid floccules substance together with resin to fill in the mineral tank.
- Avoid O-ring inside control valve falling out while rotating it on the tank.

② Install flow meter

As Figure1-2 shows, put the sealing ring into nut of flow meter, screw in water outlet; insert the sensor into flow meter.

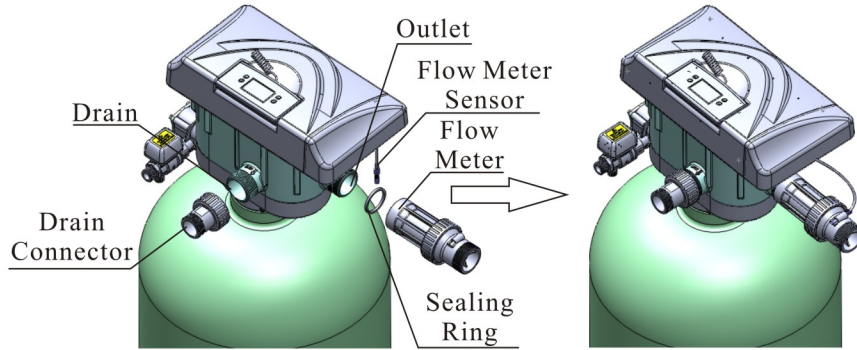

Figure 1-2

③ Pipeline connection

- As Figure1-3 shows, install a pressure gauge in water inlet.
- Install valves A.B.C.D in inlet, outlet and pipeline as showed in Figure 1-3. Valve D is a sampling valve.
- Inlet pipeline should be in parallel with outlet pipeline. Support inlet and outlet pipeline with fixed holder.

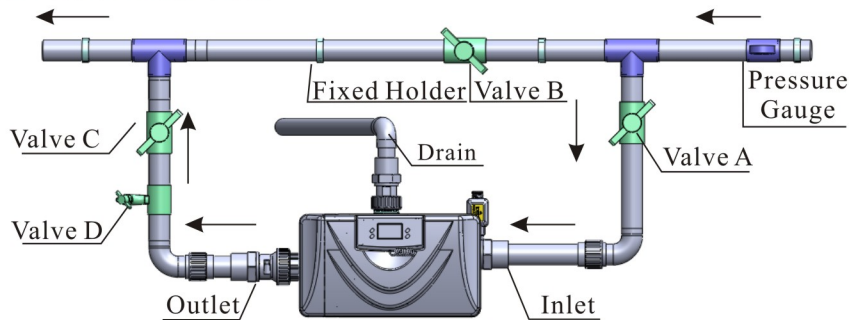

Figure 1-3

Note:

- If making a soldered copper installation, do all sweat soldering before connecting pipes to the valve. Torch heat will damage plastic parts.
- When turning threaded pipe fittings onto plastic fitting, use care and do not cross thread or break valve.
- If the valve belongs to time clock type (F111A1, F111B1), there are no step ②.

④ Install drain pipeline (If no special requirement, the standard DLFC is No.7704)

- Based on product configuration, for 63620/63520, if tank diameter is 1000 mm, install step d. If the tank size is 900 mm or 1200mm, you need to ask supplier for another injector & DLFC. Install it as below steps.
- Change 7704 to the corresponding injector for the tank which is 900 mm or 1200mm.
- Change DLFC to the corresponding DLFC for the tank which is 900 mm or 1200mm.
- Insert drain line flow control into drain hose connector, then screw it into drain outlet, and lock it.
- Glue the drain outlet with UPVC (DN40). Put drain outlet pipe to sewer as showed in the Figure 1-4.
- For filter valve 53620/53520, there is no DLFC, install UPVC (DN50) according to step e.

Note:

- Control valve should be higher than drain outlet, and be better not far from the drain hose.
- Be sure not connect drain with sewer, and leave a certain space between them, avoid wastewater be absorbing to the water treatment equipment.

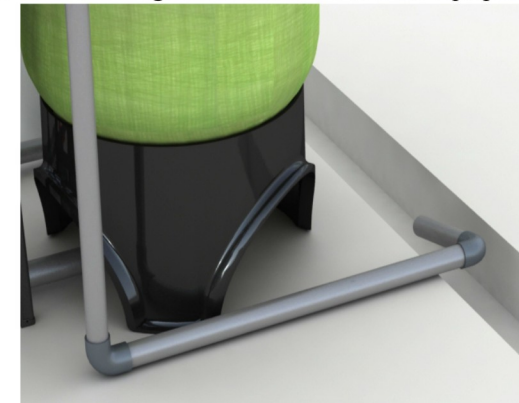

Figure 1-4

⑤ Connect brine tube

- As Figure1-5 shows, use UPVC (DN20) to connect brine valve with brine line connector

Note:

- Keep brine line short and smooth. Elbows no more than four to avoid bad brine.
- Brine valve must be installed.

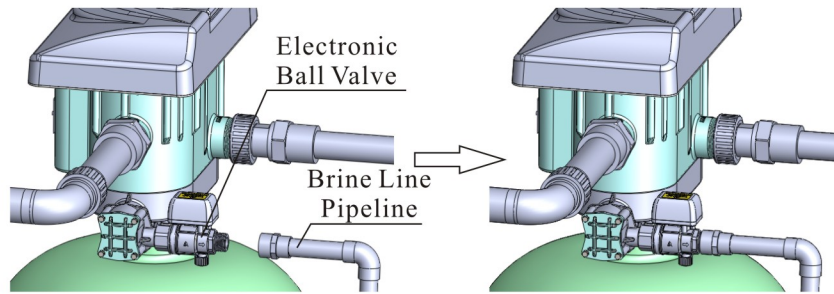
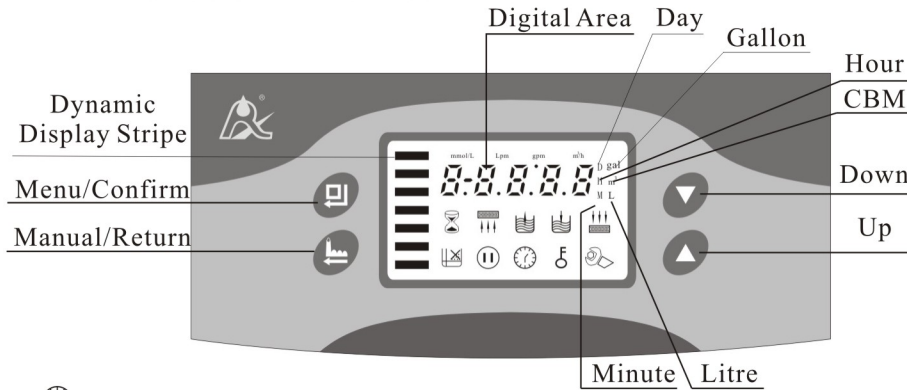

Figure 1-5

2. Basic Setting & Usage

2.1. The Function of PC Board



- A. “🕒” Time of day indicator
 “🕒” Light on, display the time of day
- B. “🔒” Button lock indicator
 ● “🔒” Light on, indicate the buttons are locked. At this moment, press any single button will not work (No operation in one minute, “🔒” will light on and lock the buttons.)
 ● Solution: Press and hold both “⬆️” and “⬇️” for 5 seconds until the “🔒” light off.
- C. “🔧” Program mode indicator
 ● “🔧” Light on, enter program display mode. Use “⬆️” or “⬇️” to view all values.
 ● “🔧” Flash, enter program set mode. Press “⬆️” or “⬇️” to adjust values.
- D. “👉” Manu/Confirm button
 ● Press “👉”, “🔧” light on, enter program display mode and use “⬆️” or “⬇️”

to view all values.

- In program display mode, press “👉”, “🔧” flash, enter program set mode, press “⬆️” or “⬇️” and adjust values.
- Press “👉” after all program are set, and then the voice “Di” means all setting are success and return program display mode.
- E. “⬆️” Manual/Return button
 ● Press “⬆️” in any status, it can proceed to next step. (Example: Press “⬆️” in Service status, it will start regeneration cycles instantly; Press “⬆️” while it is in Backwash status, it will end backwash and go to Brine & Slow Rinse at once.)
 ● Press “⬆️” in program display mode, and it will return in Service; Press “⬆️” in program set mode, and it will return program display mode.
 ● Press “⬆️” while adjusting the value, then it will return program display mode directly without saving value.
- F. Down “⬆️” and Up “⬇️”
 ● In program display mode, press “⬆️” or “⬇️” to view all values.
 ● In program set mode, press “⬆️” or “⬇️” to adjust values
 ● Press and hold both “⬆️” and “⬇️” for 5 seconds to unlock the buttons.

2.2. Basic Setting & Usage

A. Parameter specification

Function	Indicator	Factory Default	Parameter Set Range	Instruction
Time of Day	🕒	Random	00:00 ~ 23:59	Set the time of day when use; “:” flash.
Control Mode	A-01	A-01	A-01	Regenerate on the day although the available volume of treated water drops to zero (0). Regeneration starts at the regeneration time.
			A-02	Regenerate immediately when the available volume of treated water drops to zero(0).
			A-03	Meter Delayed Regeneration type, but by setting Resin Volume, Feed Water Hardness, Regeneration Factor, the controller will calculate the System Capacity. Regeneration mode same as A-01.

MODEL 53520/53620/63520/63620

8. Loss of resin through drain line.	A. Air in water system. B. Bottom strainer broken. C. Improperly sized drain line control.	A. Assure that well system has proper air eliminator control. B. Replace new strainer. C. Check for proper drain rate.
9. Control cycle continuously.	A. Locating signal wiring breakdown. B. Controller is faulty. C. Foreign material stuck the driving gear. D. Time of regeneration steps were set to zero.	A. Check and connect locating signal wiring. B. Replace controller. C. Take out foreign material. D. Check program setting and reset.
10. Drain flows continuously.	A. Internal valve leak. B. Power off when in back wash or fast rinse.	A. Check and repair valve body or replace it. B. Adjust valve to service position or turn off bypass valve and restart when electricity supply.
11. Interrupted or irregular brine.	A. Water pressure too low or not stable. B. Injector is plugged or faulty. C. Air in resin tank. D. Floccules in resin tank during up-flow regeneration.	A. Increase water pressure. B. Clean or replace injector. C. Check and find the reason. D. Clean the floccules in resin tank.
12. Water flow out from drain or brine pipe after regeneration.	A. Foreign material in valve which makes valve can't be closed completely. B. Hard water mixed in valve body. C. Water pressure is too high which result in valve doesn't get the right position. D. Ball valve is not shut-off completely	A. Clean foreign material in valve body. B. Change valve core or sealing ring. C. Reduce water pressure or use pressure release function. D. Repair ball valve or replace it .
13. Salt water in soften water	A. Foreign material in injector or injector fails to work. B. Brine valve cannot be shut-off. C. Time of fast rinse too short.	A. Clean and repair injector. B. Repair brine valve and clean it. C. Extend fast rinse time.
14. Circle capacity decreases.	A. Regenerate not properly. B. Resin is fouled or bad. C. Salt setting not proper. D. Softener setting not proper. E. Raw water quality deterioration. F. Turbin has already been stucked.	A. Regenerate according to right way. B. Increase backwash flow rate and time, clean or change resin. C. Readjust brine drawing time. D. According to the test of outlet water, recount and reset. E. Regenerate unit by manual temporary then reset regeneration cycle. F. Disassemble flow meter and clean it or replace a new turbine.

MODEL 53520/53620/63520/63620

B.Controller Fault

Problem	Cause	Correction
1. All indicators display on front panel.	A. Wiring of front panel with controller fails to work. B. Control board is faulty. C. Transformer damaged. D. Electrical service not stable. E. Display board is faulty.	A. Check and replace the wiring. B. Replace control board. C. Check and replace transformer. D. Check and adjust electrical service. E. Replace display board.
2. No display on front panel	A. Wiring of front panel with controller fails to work. B. Front panel damaged. C. Control board damaged. D. Adapter damaged.	A. Check and replace wiring. B. Replace front panel. C. Replace control board. D. Replace adapter.
3. E11 Flash	A. Wiring of locating board with controller fails to work. B. Locating board damaged. C. Mechanical driven failure. D. Faulty control board. E. Wiring of motor with controller is fault. F. Motor 1 damaged.	A. Replace wiring. B. Replace locating board. C. Check and repair mechanical part. D. Replace control board. E. Replace wiring. F. Replace motor 1.
4. E21 Flash	A. Wiring of locating board with controller fails to work. B. Locating board damaged. C. Mechanical driven failure. D. Control board damaged. E. Wiring of motor with controller fails to work. F. Motor 2 damaged.	A. Replace wiring. B. Replace locating board. C. Check and repair mechanical part. D. Replace control board. E. Replace wiring of motor with controller. F. Replace motor 2.
5. E12 or E22 Flash	A. Hall component on locating board damaged. B. Wiring of locating board with controller fails to work. C. Control board damaged.	A. Replace locating board. B. Replace wiring. C. Replace control board.
5. E3 or E4 Flash	A. Control board is faulty.	A. Replace control board.

capacity as follow:

Press and hold both “▲” and “▼” for 5 seconds to lift the lock status. Press “⏏”, and the “🔧” light on, then press “▼”, the digital area show the control mode. If it shows A-01 or A-02, press “▼” three times, and the digital area will show the given water treatment capacity(If the control mode shows A-03 or A-04, then press “▼” four times, the digital area will show the feed water hardness); Press “⏏” again, “🔧” and digital flash. Press “▲” or “▼” continuously, reset the capacity value (Or water hardness). Press “⏏” and hear a sound “Di”, then finish the adjustment. Press “⏏” exit and turn back the service status.

The estimation of water treatment capacity, you can refer to the professional application specification. When select A-03 or A-04 intelligent control mode, the control will automatically calculate the water treatment capacity by setting resin volume, feed water hardness and regeneration factor.

④ For A-01 or A-03 control mode (Delayed regeneration type), please pay attention to whether the time is current or not. If the time is not right, you can adjust as follow: After lifting the lock status, press “⏏”, the “🔧” and “🕒” light on. Then press “⏏”, the “🔧” and hour value flash. Press “▲” or “▼” continuously, reset the hour value; Press “⏏” again, and minute value flash. Press “▲” or “▼” continuously, reset the minute value; Press “⏏” and hear a sound “Di”, then finish the adjustment. Press “⏏” exit and turn back the service status.

The regeneration parameters have been set when control valve left factory. Generally, it does not need to reset. If you want enquiry and modify the setting, you can refer to the professional application specification.

3.Applications

3.1.Flow Chart

Flow Chart for 63620/63520:

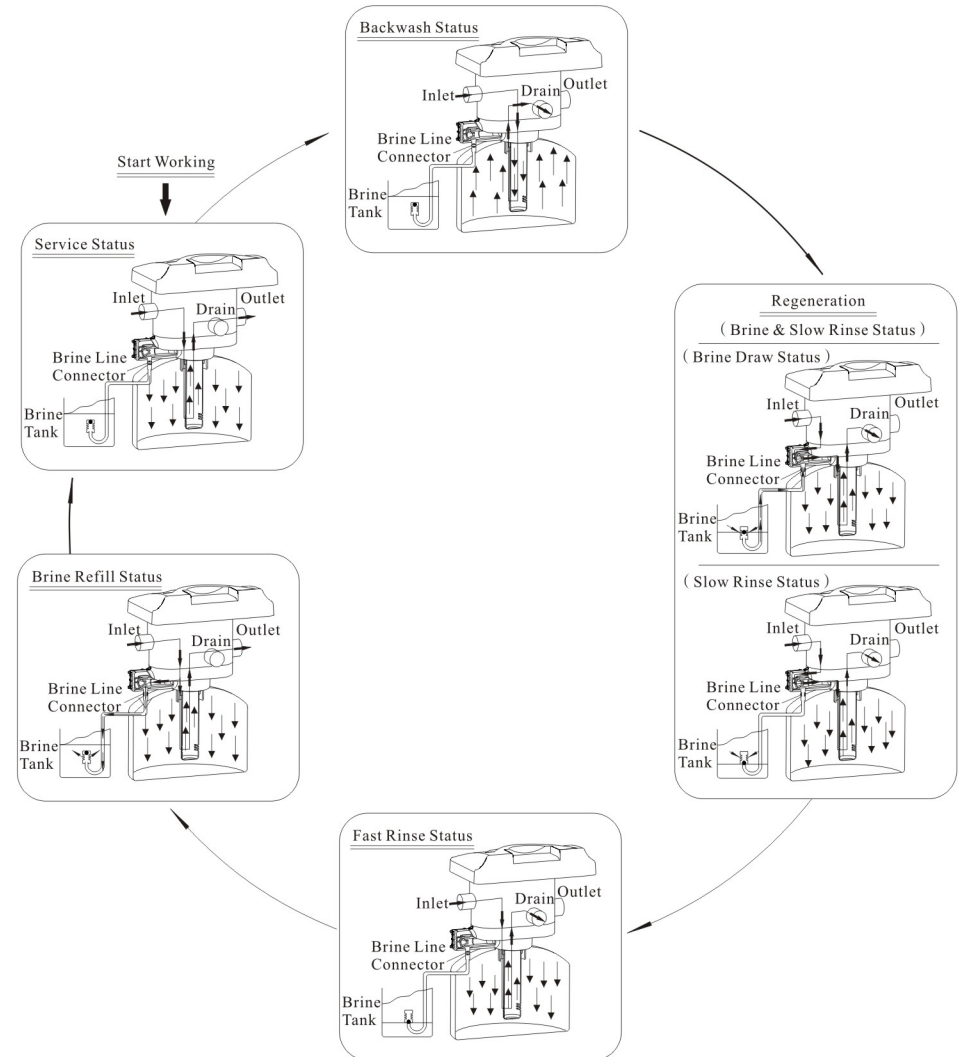

Note: Filter valve 53620/53520 only has working processes: Service, Backwash, and Fast Rinse.

3.2. The Function and Connection of PC Board

Open the front cover of control valve, you will see the main control board and connection ports as below:

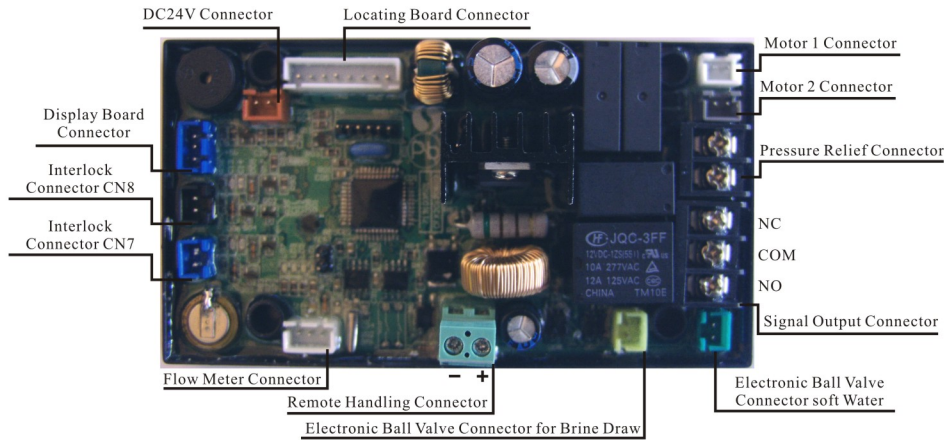

Functions on PC board:

Function	Application	Explanation
Signal output connector b-01	Outlet solenoid valve	If system strictly require no hard water flow from outlet or controlling the liquid level in water tank.
	Inlet pump	Increase pressure for regeneration or washing. Use the liquid level controller to control inlet pump to ensure there is water in tank.
Signal output connector b-02	Inlet solenoid valve or inlet pump	When inlet pressure is high, it needs to close water inlet when valve is rotating to protect motor.
Pressure relief connector	Control the inlet bypass to release pressure	When valve is rotating, pressure relief connector opened to prevent pressure increasing rapidly.
Interlock connector	To ensure only one control valve regeneration or washing in system.	Use in RO pre-treatment, water supply together but regeneration in turn, second grade ion exchange equipment, etc.
Remote handling connector	Receipt signal to make the control rotate to next circle	It is used for on-line inspection system, PC connection, and realize automatically or remote controlling valve.

A. Signal Output Connector

1). Control Solenoid Valve (Set b-01)

① Solenoid valve on outlet controls water level in brine tank.

Instruction: If system strictly require no hard water flow from outlet in regeneration cycle(Mainly for no hard water flow out when valve is switching or valve in backwash or brine drawing position), a solenoid valve could be installed on outlet, the wiring refers to Figure 3-1.

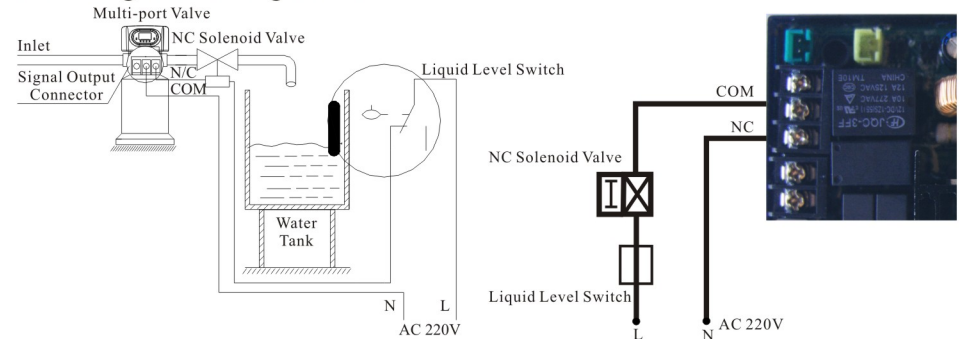

Figure 3-1 Wiring of Solenoid Valve on Outlet

Function:

When valve in service status, if soft water tank is short of water, solenoid valve is opened to supply soft water, but if water tank has enough water, solenoid valve is closed, so no soft water supplied.

When the valve in backwash status, there is no signal output. So, solenoid valve is closed, and no water flow into soft water tank.

② Solenoid valve on inlet(Set b-02)

Instruction: When inlet pressure exceeds 0.6MPa, install a solenoid valve on inlet. Control mode is b-02. Pressure relieved when valve switching, the wiring refers to Figure 3-2. As Figure 3-3 shows, it also can use the pressure relief port to work.

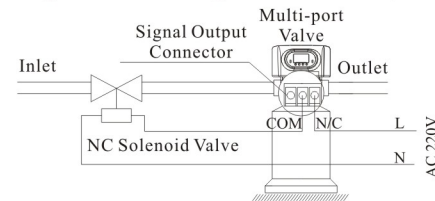

Figure 3-2 Wiring of Solenoid Valve on Inlet

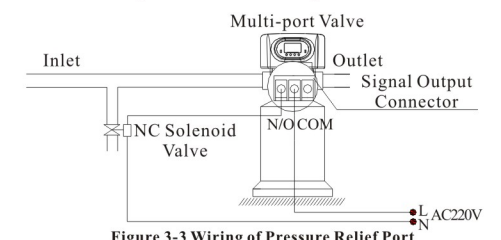

Figure 3-3 Wiring of Pressure Relief Port

Instruction:

When inlet pressure is high, install a solenoid valve on inlet to ensure valve

switching properly. When valve is exactly at position of Service, Backwash, Brine & Slow Rinse, Brine Refill and Fast Rinse, solenoid valve is open. When valve is switching, solenoid valve is closed, no water flow into valve to ensure valve switching properly. It could prevent the problem of mix water and water hammer.

Use interlock cable to realize valves in parallel and series in same system which is suited for RO pretreatment system or second grade Na⁺ system. The wiring refers to Figure 3-4:

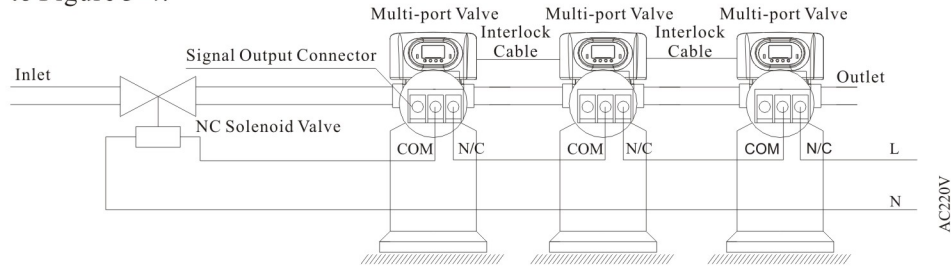

Figure 3-4 Wiring of Solenoid Valve on Inlet

2).Liquid Level Controller Controls Inlet Pump(Two-phase motor)(Set b-01)

Instruction: For the system using well or middle-tank supplying water, switch of liquid level controller and valve together to control pump opening or closing. The wiring refers to Figure 3-5:

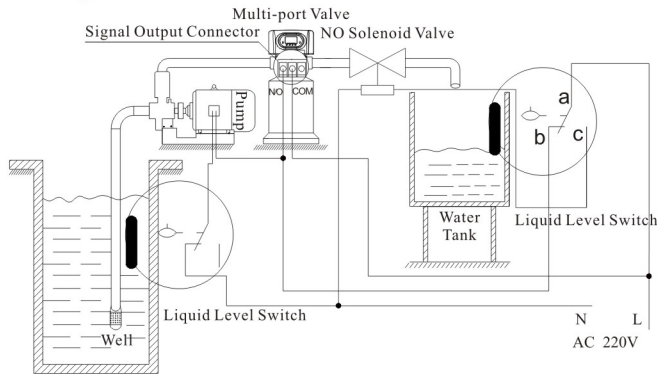

Figure 3-5 Wiring of Liquid Level Controller Controlling Inlet Pump

Function:

When valve in service status, if water tank is short of water, start up pump, but if water tank has enough water, the switch of liquid level controller is closed, so pump doesn't work.

When valve in regeneration cycle, inlet always has water no matter what is water condition in water tank. As for Runxin valve no water passing outlet in regeneration cycle,

which ensures no water fill into brine tank. A liquid switch at the top opening well or in middle water tank in RO system protects pump from working without water in case of out of raw water.

3).Liquid Level Switch in Water Tank Controls Inlet Pump (Three-phase,Figure 3-6) (Set b-01)

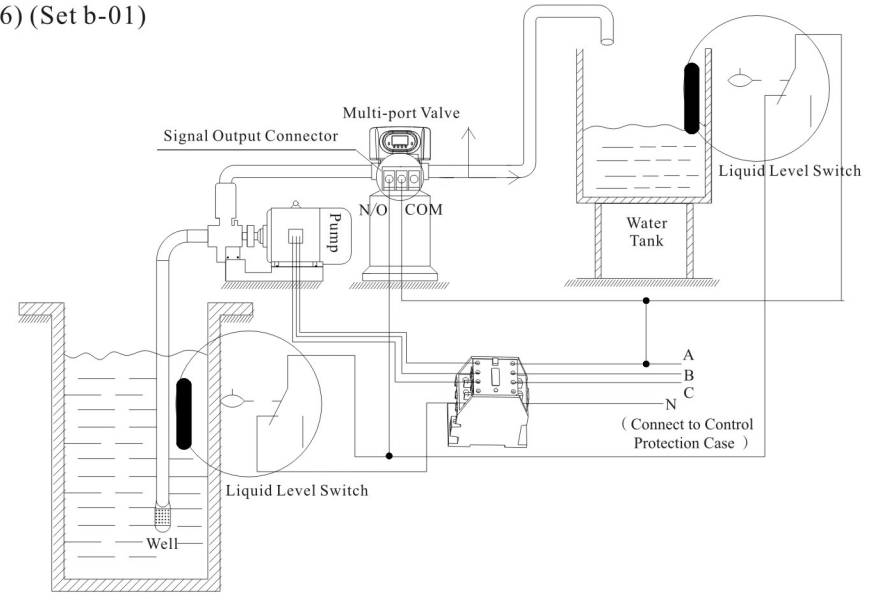

Figure 3-6 Wiring of Liquid Level Controller Controlling 380V Inlet Pump

4).Control Inlet Booster Pump(Set b-01 or b-02)

Instruction: If inlet water pressure is less than 0.15 MPa, which makes rinse drawing difficult, a booster pump is suggested to be installed on inlet. Control mode is b-01. When system in regeneration cycle, booster pump is open, the wiring refers to Figure 3-7.If the booster pump current is bigger than 5A, system needs to install a contactor, the wiring refers to Figure 3-8.

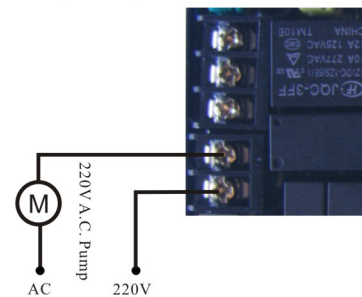

Figure 3-7 Wiring of Booster Pump on Inlet

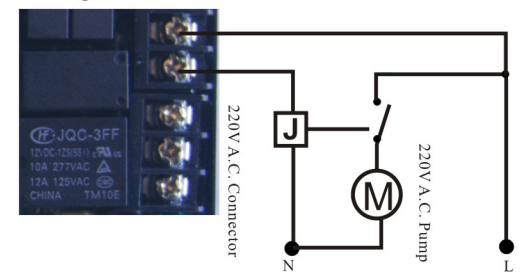

Figure 3-8 Wiring of Booster Pump on Inlet

B. Interlock

Instruction: In the parallel water treatment system, it ensures only one valve in regeneration or washing cycle and (n-1) valves in service, that is, realizing the function of supplying water simultaneously and regenerating individually.

In the series water treatment system which is suited for RO pretreatment system or second grade Na⁺ system, it ensures only one valve in regeneration or washing cycle and every grade has water when in regeneration or washing. Wiring refers to Figure 3-9.

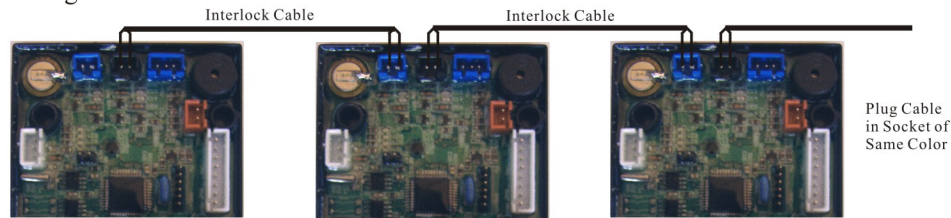

Figure 3-9 Network System Wiring with Interlock Cable

Use interlock cable to connect CN8 to CN7 on next valve in the loop.

One system with several valves, if interlock cable is disconnected, the system is divided into two individual systems.

C. Pressure Relief Output

Runxin valve will cut off feeding water to drain line when it switches in regeneration cycles. Thus in some water treatment systems, e.g. Deep Well, one booster pump was installed on the inlet to increase the system water feeding pressure, this cut-off will cause pressure on inlet rising so fast to damage the valve. Pressure Relief Output can be used to avoid this problem. The wiring refers to Figure 3-10.

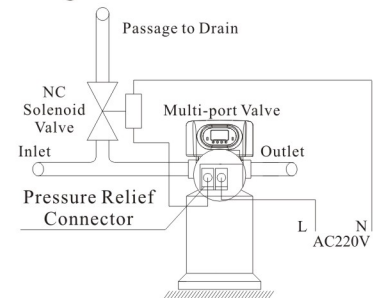

Figure 3-10 Wiring of Pressure Relief Output

D. Remote Handling Connector

Online TDS meter monitors treated water other than a flow meter, or PLC

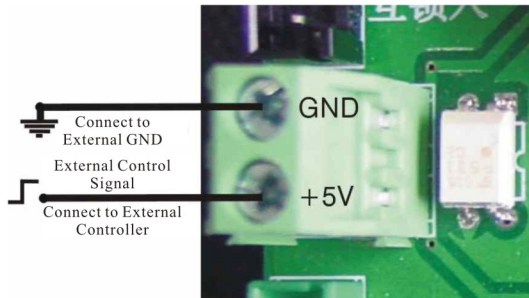

Figure 3-11 Wiring of Remote Input

controls the regeneration time. When the controller receives a contact closure from above instruments, regeneration begins. The wiring refers to Figure 3-11.

E. Interlock System

2 or more than 2 valves are interlocked connecting in one system and all valves are in service but regenerate individually. The wiring refers to Figure 3-12.

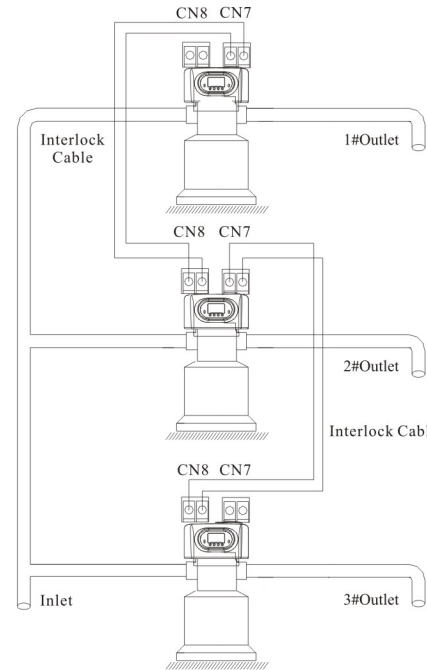

Figure 3-12 Interlock System

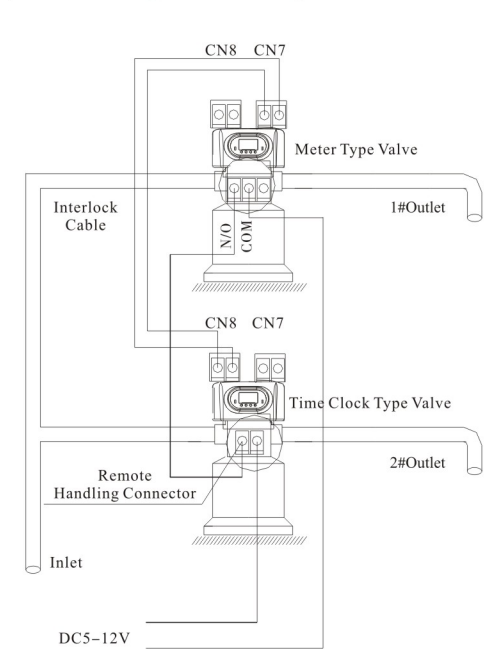

Figure 3-13 Series System

F. Series System

This is 2 or more than 2 valve systems, all in service, with one flow meter for the entire system. For the time type valve, the regeneration time should be set and adjusted to the Max; for the volume type valve, connect its signal output connector with the remote handle connector of the time type valve. That can realize the function of supplying water simultaneously and regenerating orderly. The wiring refers to Figure 3-13.

3.3. System Configuration and Flow Rate Curve

A. Product Configuration

Fixed bed & softener valve configuration with tank, resin volume, brine tank and injector.

MODEL 53520/53620/63520/63620

Tank Size (mm)	Resin Volume (L)	Flow Rate (t/h)	Brine Tank Size (mm)	The Minimum Salt Consumption for Regeneration(Kg)	Injector Model
φ900×2400	900	16.0	φ1080×1460	135.00	7703
φ1000×2400	1100	20.0	φ1240×1575	165.00	7704
φ1200×2400	1500	28.0	φ1360×1690	225.00	7705

Attention: The flow rate calculation is based on linear velocity 25m/h; the minimum salt consumption for regeneration calculation is based on salt consumption 150g / L (Resin).

Filter valve configuration with tank, resin volume, brine tank and injector:

Tank Size	Filter Material Volume	Carbon Filter Valve		Sand Filter Valve	
		Filtering Flow Rate	Backwash Flow Rate	Filtering Flow Rate	Backwash Flow Rate
mm	L	m ³ /h	m ³ /h	m ³ /h	m ³ /h
φ750×1800	450	5.3	15.9	11	23.8
φ900×2400	900	7.6	22.9	15.9	34.3

Attention: Above filtering flow rate of the carbon filter valve calculated based on linear velocity 12m/h; the backwash flow rate of the carbon filter valve calculated based on the strength of backwash 10L/(m²*s). Filtering flow rate of the sand filter valve calculated based on linear velocity 25m/h; the backwash flow rate of the sand filter valve calculated based on the strength of backwash 15L/(m²*s).

B. Flow Rate Characteristic

1).Pressure-flow Rate Curve

Filter Valve 53620/53520:

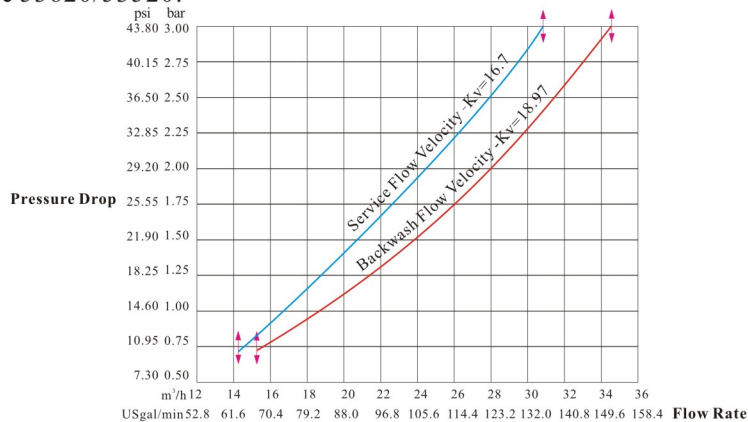

MODEL 53520/53620/63520/63620

Softener Valve 63620/63520:

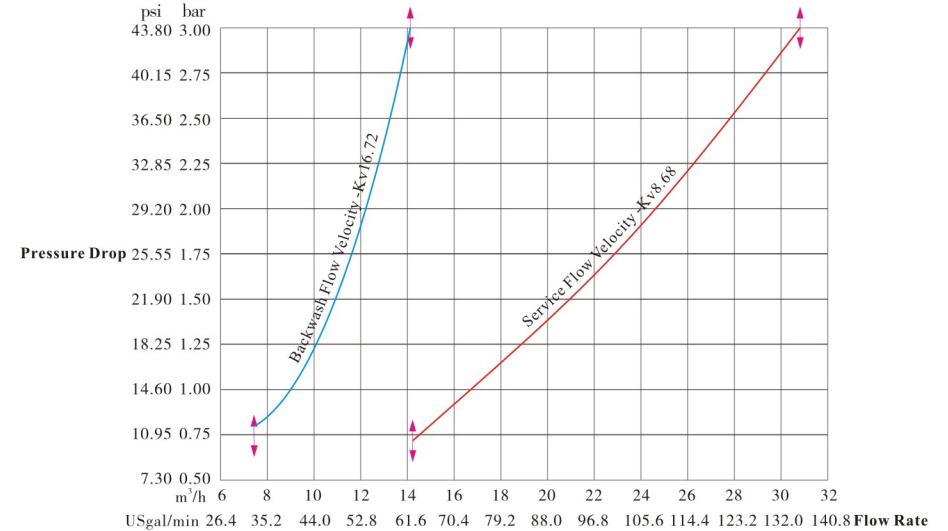

2).Injector Parameter Table

Fixed Bed 63620/63520:

Inlet Pressure	Draw Rate (L/M)		
	7703 Yellow	7704 Blue	7705 White
MPa			
0.20	39.00	49.00	55.17
0.25	45.00	55.70	63.72
0.30	49.80	63.50	69.20
0.35	54.30	68.00	73.03
0.40	57.60	72.00	76.50

3).Configuration for Standard Injector and Drain Line Flow Control

Fixed Bed 63620/63520:

Tank Dia. mm	Injector Model	Injector Color	Draw Rate	Slow Rinse	Brine Refill Flow Rate	DLFC Holes Quantity & Dia	Backwash / Fast Rinse
			L/m	L/m			L/m
900	7703	Yellow	49.8	34.0	45.5	1 × φ6	11
1000	7704	Blue	63.5	44.5	45.5	3 × φ6	13
1200	7705	White	69.2	49.2	47.0	6 × φ6	17

Remark:

- Above data for the product configuration and relevant characteristics are only for reference. When put in practice, please subject to the different requirements of raw water hardness and application.
- Above parameter is tested under 0.3MPa inlet pressure.
- Holes quantity is the holes number on DLFC. Diameter of hole is φ6, the number refers to above table.
- Injectors 7703, 7704, 7705 correspond to material numbers 5468019, 5468020, 5468021.

3.4.Parameter Settlement

① Service time T1

Water treatment capacity :

$$Q = V_R \times K \div Y_D (m^3)$$

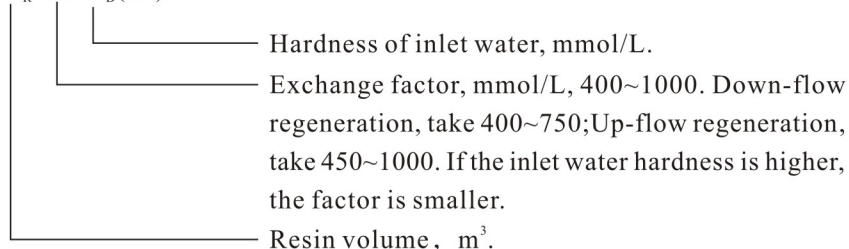

By days:

$$T1 = Q \div Q_d (Day)$$

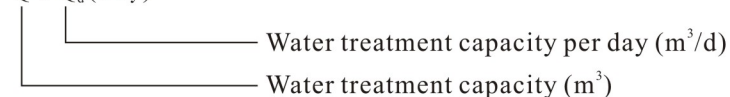

② Backwash time T2

It is subject to the turbidity of inlet water. Generally, it is suggested to be set 10 ~ 15 minutes. The higher the turbidity is, the longer backwash time shall be set. However, if the turbidity is more than 5FTU, it is better to install a filter in front of the exchanger.

③ Brine & slow rinse time T3

$$T3 = (40 \sim 50) \times H_R (min.)$$

Generally, $T3 = 45H_R (min.)$

In this formula, H_R — The height of resin in exchange tank (m.)

④ Brine refill time T4

Down-flow regeneration: $T4 = 0.45 \times V_R \div \text{Brine refill speed (min.)}$

Up-flow regeneration: $T4 = 0.34 \times V_R \div \text{Brine refill speed (min.)}$

In this formula, V_R — Resin volume (m³)

The Brine refill speed is related to inlet water pressure. It is suggested to lengthen 1~2 minutes of calculated brine refilling time to make sure there is enough water in tank. (The condition is that there is a level controller installed in the brine tank)

⑤ Fast rinse time T5

$$T5 = 12 \times H_R (min.)$$

Generally, the water for fast rinse is 3 ~ 6 times of resin volume. It is suggested to be set 10 ~ 16 minutes, but subject to the outlet water reaching the requirement.

⑥ Exchange factor

Exchange factor = $E / (k \times 1000)$

In this formula, E — Resin working exchange capability (mol/m³), it is related to the quality of resin. Down-flow regeneration, take 800 ~ 900. Up-flow regeneration, take 900 ~ 1200.

K — Security factor, always take 1.2 ~ 2. it is related to the hardness of inlet water: the higher the hardness is, the bigger the K is.

⑦ Regeneration time: The whole cycle for regeneration is about two hours. Please try to set up the regeneration time when you don't need water according to the actual situation.

The calculation of parameters for each step is only for reference, the actual proper time will be determined after adjusting by water exchanger supplier. This calculation procedure of softener is only for industrial application; it is not suitable for small softener in residential application.

3.5.Parameter Enquiry and Setting

3.5.1.Parameter Enquiry

When “ \mathcal{E} ” light on, press and hold both “ \blacktriangle ” and “ \blacktriangledown ” for 5 seconds to lift the button lock status; then press “ E ” and “ D ” light on, enter to program display mode; press “ \blacktriangle ” or “ \blacktriangledown ” to view each value according to below process. (Press “ E ” exit and turn back to service status)

63620:Take A-01 as a sample

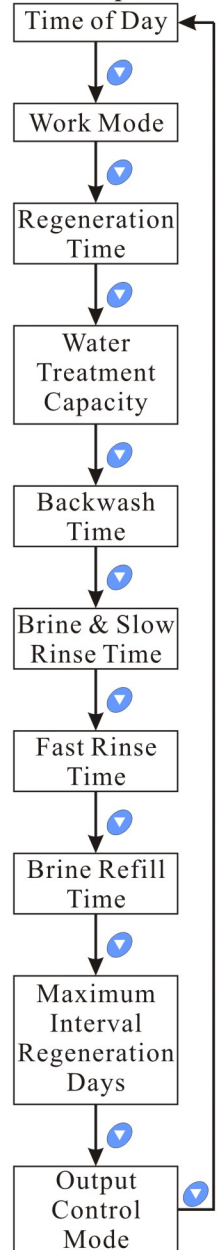

63520:

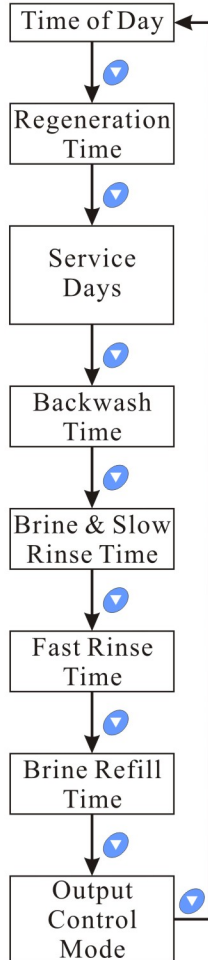

53620:Take A-01 as a sample

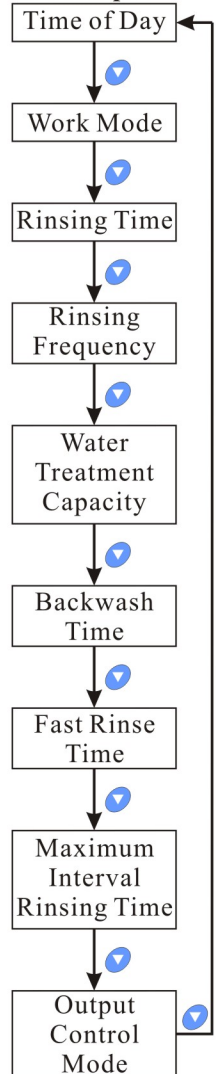

53520:

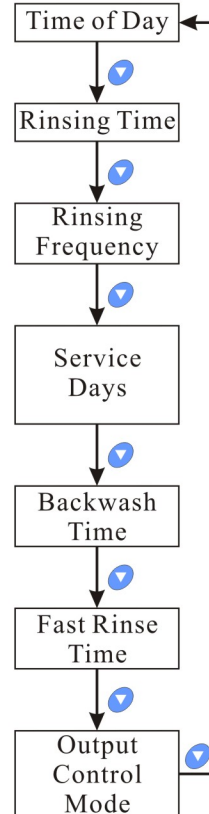

























































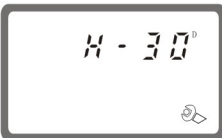

3.5.2.Parameter Setting (Take 63620 A-01 as a sample)

In program display mode, press “” and enter into program set mode. Press “” or “” to adjust the value.













3.5.3.The Steps of Parameter Setting

Items	Process Steps	Symbol
Time of Day	When time of day “12:12” continuously flash, it reminds to reset; 1. Press “” to enter into program display mode; both “” and “” symbol light on, “:” flash; Press “”, both “” and hour value flash, through “” or “” to adjust the hour value; 2. Press “” again, both “” and hour value flash, through “” or “” to adjust the minute value; 3. Press “” and hear a sound “Di”, then finish adjustment, press “” to turn back.	
Control Mode	1. In control mode display status, press “” and enter into program set mode, “” and 01 value flash; 2. Press “” or “”, set the value to be A-01, A-02, A-03 or A-04 control mode 3. Press “” and hear a sound “Di”, then finish adjustment, press “” to turn back.	
Regeneration Time	1. In regeneration time display status, press “” and enter into program set mode. “” and 02 flash; Press “” or “” to adjust the hour value; 2. Press “” again, “” and 00 flash, press “” or “” to adjust the minute value; 3. Press “” and hear a sound “Di”, then finish adjustment, press “” to turn back.	
Water Treatment Capacity	1. In water treatment capacity display status, it shows “” and 200.0. Press “” and enter into program set mode. “” and 200 flash; 2. Press “” or “” to adjust the integer of water treatment capacity value; 3. Press “” and decimal part flash. Press “” or “” to adjust the decimal of water treatment capacity value; 4. Press “” to finish adjustment, press “” to turn back.	

<p>Backwash Time</p>	<p>1. In backwash time display status, it shows “” and 2-10:00. Press “” and enter into program set mode. “” and 10 flash; 2. Press “” or “” to adjust the minutes of backwash; 3. Press “” and 00 flash. Press “” or “” to adjust the seconds of backwash; 4. Press “” to finish adjustment, press “” to turn back.</p>	
<p>Brine & Slow Rinse Time</p>	<p>1. In brine & slow rinse time display status, it shows “” and 3-60:00. Press “” to enter into program set mode. “” and 60 flash; 2. Press “” or “” to adjust the minutes of brine; 3. Press “” and 00 flash. Press “” or “” to adjust the seconds of brine; 4. Press “” to finish adjustment, press “” to turn back.</p>	
<p>Fast Rinse Time</p>	<p>1. In fast rinse time display status, it shows “” and 4-10:00. Press “” to enter into program set mode. “” and 10 flash; 2. Press “” or “” to adjust the minutes of fast rinse; 3. Press “” and 00 flash. Press “” or “” to adjust the seconds of fast rinse; 4. Press “” to finish adjustment, press “” to turn back.</p>	
<p>Brine Refill Time</p>	<p>1. In brine refill time display status, it shows “” and 5-05:00. Press “” and enter into program set mode. “” and 05 flash; 2. Press “” or “” to modify the minutes of brine refill; 3. Press “” and 00 flash. Press “” or “” to adjust the seconds of brine refill; 4. Press “” to finish adjustment, press “” to turn back.</p>	
<p>Maximum Interval Regeneration Days</p>	<p>1. In maximum interval regeneration days display status, it shows H-30. Press “” and enter into program set mode. “” and 30 flash; 2. Press “” or “” to adjust the interval regeneration days; 3. Press “” to finish adjustment, press “” to turn back.</p>	



<p>Signal Output Mode</p>	<p>1. In signal output mode display status, it shows b-01. Press “” and enter into program set mode. “” and 01 flash; 2. Press “” or “” to adjust the mode; 3. Press “” to finish adjustment, press “” to turn back.</p>	
----------------------------------	--	---



For example, the fast rinse time of a softener is 12 minutes. After regenerating, the chloridion in the outlet water is always higher than normal, indicating that the time is not enough for fast rinse. If you want the time to set to 15 minutes, the modification steps as follows:



- ① Press and hold both “” and “” to lift the button lock status (“” light off);
 - ② Press “”, and “” light on;
 - ③ Press “” or “” continuously until “” light on. Then the digital area shows: 4-12:00M;
 - ④ Press “”, “” and 12 flash;
 - ⑤ Press “” continuously until 12 changed to 15;
 - ⑥ Press “”, there is a sound “Di” and the figure stop flashing; the program back to enquiry status
 - ⑦ If you want to adjust other parameters, you can repeat the steps from ② to ⑤;
- If you don't, press “” and quit from the enquiry status, the display will show the current service status.



3.6.Trial Running



After installing the multi-functional flow control valve on the resin tank with the connected pipes, as well as setting up the relevant parameter, please conduct the trail running as follows:

- A. Close the inlet valve B & C, and open the bypass valve A. After cleaning the foreign materials in the pipe, close the bypass valve A. (As Figure 1-4 shows)
- B. Fill the brine tank with the planned amount of water and adjust the air check valve. Then add solid salt to the tank and dissolve the salt as much as possible.
- C. Switch on power. Press “” and go in the Backwash position; when “” light on, slowly open the inlet valve B to 1/4 position, making the water flow into the resin tank; you can hear the sound of air-out from the drain pipeline. After all air is out of pipeline, then open inlet valve B completely and clean the foreign materials in the resin tank until the outlet water is clean. It will take 8~10 minutes to finish the whole process.

D. Press “”, turning the position from Backwash to Brine & Slow Rinse; “” light on and enter in the process of Brine & Slow Rinse. The air check valve close when control valve finished sucking brine, then slow rinse start to work. It is about 60~65minutes for whole process.

E. Press “”, turning the position from Brine & Slow Rinse to Fast Rinse. “” light on. It takes about 10~15 minutes, take out some outlet water for testing: if the water hardness reach the requirement, and the chloridion in the water is almost the same compared with the inlet water, then go to the next step.

F. Press “”, turning the position from Fast Rinse to Brine Refill. “” light on and it indicates the brine tank is being refilled with water to the required level. It takes about 5~6 minutes, then add solid salt to the brine tank.

G. Press “”, making the control valve return to Service Status; “” light on and start to running.

Note:

- When the control valve enter into the regeneration status, all program can be finished automatically according to the setting time; if you want one of steps terminated early, you can press “”.

- If water inflows too fast, the media in tank will be damaged. When water inflows slowly, there is a sound of air emptying from drain pipeline.

- After changing resin, please empty air in the resin according to the above Step C.

- In the process of trial running, please check the water situation in all positions, ensuring there is no resin leakage.

- The time for Backwash, Brine & Slow Rinse, Brine Refill and Fast Rinse position can be set and executed according to the calculation in the formula or suggestions from the control valve suppliers.

3.7.Trouble-Shooting

A.Control Valve Fault

Problem	Cause	Correction
1. Softener fails to regenerate.	A. Electrical service to unit has been interrupted. B. Regeneration cycles set incorrect. C. Controllor is defective. D. Motor fails to work.	A. Assure permanent electrical service (Check fuse, plug, pull chain or switch). B. Reset regeneration cycles. C. Replace controllor. D. Replace motor.
2. Regeneration time is not correct.	A. Time of day not set correctly. B. Power failure more than 3 days.	Check program and reset time of day.

3. Softener supply hard water.	A. Bypass valve is open or leaking. B. No salt in brine tank. C. Injector plugged. D. Insufficient water flowing into brine tank. E. Internal valve leak. F. Regeneration cycles not correct. G. Shortage of resin. H. Bad quality of feed water or turbine blocked.	A. Close or repair bypass valve. B. Add salt to brine tank and maintain salt level above water level. C. Change or clean injector. D. Check brine tank refill time. E. Change valve body. F. Set correct regeneration cycles in the program. G. Add resin to mineral tank and check whether resin leaks. H. Reduce the inlet turbidity, clean or replace turbine.
4. Softener fails to draw brine.	A. Line pressure is too low. B. Brine line is plugged. C. Brine line is leaking. D. Injector is plugged. E. Internal valve leak. F. Drain line is plugged. G. Sizes of injector and DLFC not match with tank. H. Ball valve or cable failure.	A. Increase line pressure. B. Clean brine line. C. Replace brine line. D. Clean or replace injector. E. Replace valve body. F. Clean drain line flow control. G. Select correct injector size and DLFC according to the instruction manual. H. Replace ball valve or cable.
5. Unit used too much salt.	A. Improper salt setting. B. Excessive water in brine tank.	A. Check salt usage and salt setting. B. See problem No.6.
6. Excessive water in brine tank.	A. Overlong refilling time. B. Remain too much water after brine. C. Foreign material in brine valve and plug drain line flow control. D. Not install safety brine valve but power failure whiling salting. E. Safety brine valve breakdown. F. Ball valve doesn't close.	A. Reset correct refilling time. B. Check the injector and make sure no stuff in the brine pipe. C. Clean brine valve and brine line. D. Stop water supplying and restart or install safety brine valve in salt tank. E. Repair or replace safety brine valve. F. Close or replace ball valve or cable.
7. Pressure lost or rust in pipe line	A. Iron in the water supply pipe. B. Iron mass in the softener. C. Fouled resin bed. D. Too much iron in the raw water.	A. Clean the water supply pipe. B. Clean valve and add resin cleaning chemical, increase frequency of regeneration. C. Check backwash, brine draw and brine tank refill. Increase frequency of regeneration and backwash time. D. Iron removal equipment is required to install before softening.

MODEL 53520/53620/63520/63620

8. Loss of resin through drain line.	A. Air in water system. B. Bottom strainer broken. C. Improperly sized drain line control.	A. Assure that well system has proper air eliminator control. B. Replace new strainer. C. Check for proper drain rate.
9. Control cycle continuously.	A. Locating signal wiring breakdown. B. Controller is faulty. C. Foreign material stuck the driving gear. D. Time of regeneration steps were set to zero.	A. Check and connect locating signal wiring. B. Replace controller. C. Take out foreign material. D. Check program setting and reset.
10. Drain flows continuously.	A. Internal valve leak. B. Power off when in back wash or fast rinse.	A. Check and repair valve body or replace it. B. Adjust valve to service position or turn off bypass valve and restart when electricity supply.
11. Interrupted or irregular brine.	A. Water pressure too low or not stable. B. Injector is plugged or faulty. C. Air in resin tank. D. Floccules in resin tank during up-flow regeneration.	A. Increase water pressure. B. Clean or replace injector. C. Check and find the reason. D. Clean the floccules in resin tank.
12. Water flow out from drain or brine pipe after regeneration.	A. Foreign material in valve which makes valve can't be closed completely. B. Hard water mixed in valve body. C. Water pressure is too high which result in valve doesn't get the right position. D. Ball valve is not shut-off completely	A. Clean foreign material in valve body. B. Change valve core or sealing ring. C. Reduce water pressure or use pressure release function. D. Repair ball valve or replace it .
13. Salt water in soften water	A. Foreign material in injector or injector fails to work. B. Brine valve cannot be shut-off. C. Time of fast rinse too short.	A. Clean and repair injector. B. Repair brine valve and clean it. C. Extend fast rinse time.
14. Circle capacity decreases.	A. Regenerate not properly. B. Resin is fouled or bad. C. Salt setting not proper. D. Softener setting not proper. E. Raw water quality deterioration. F. Turbin has already been stucked.	A. Regenerate according to right way. B. Increase backwash flow rate and time, clean or change resin. C. Readjust brine drawing time. D. According to the test of outlet water, recount and reset. E. Regenerate unit by manual temporary then reset regeneration cycle. F. Disassemble flow meter and clean it or replace a new turbine.

MODEL 53520/53620/63520/63620

B.Controller Fault

Problem	Cause	Correction
1. All indicators display on front panel.	A. Wiring of front panel with controller fails to work. B. Control board is faulty. C. Transformer damaged. D. Electrical service not stable. E. Display board is faulty.	A. Check and replace the wiring. B. Replace control board. C. Check and replace transformer. D. Check and adjust electrical service. E. Replace display board.
2. No display on front panel	A. Wiring of front panel with controller fails to work. B. Front panel damaged. C. Control board damaged. D. Adapter damaged.	A. Check and replace wiring. B. Replace front panel. C. Replace control board. D. Replace adapter.
3. E11 Flash	A. Wiring of locating board with controller fails to work. B. Locating board damaged. C. Mechanical driven failure. D. Faulty control board. E. Wiring of motor with controller is fault. F. Motor 1 damaged.	A. Replace wiring. B. Replace locating board. C. Check and repair mechanical part. D. Replace control board. E. Replace wiring. F. Replace motor 1.
4. E21 Flash	A. Wiring of locating board with controller fails to work. B. Locating board damaged. C. Mechanical driven failure. D. Control board damaged. E. Wiring of motor with controller fails to work. F. Motor 2 damaged.	A. Replace wiring. B. Replace locating board. C. Check and repair mechanical part. D. Replace control board. E. Replace wiring of motor with controller. F. Replace motor 2.
5. E12 or E22 Flash	A. Hall component on locating board damaged. B. Wiring of locating board with controller fails to work. C. Control board damaged.	A. Replace locating board. B. Replace wiring. C. Replace control board.
5. E3 or E4 Flash	A. Control board is faulty.	A. Replace control board.

3.8.Assembly & Parts

63620 Structure:

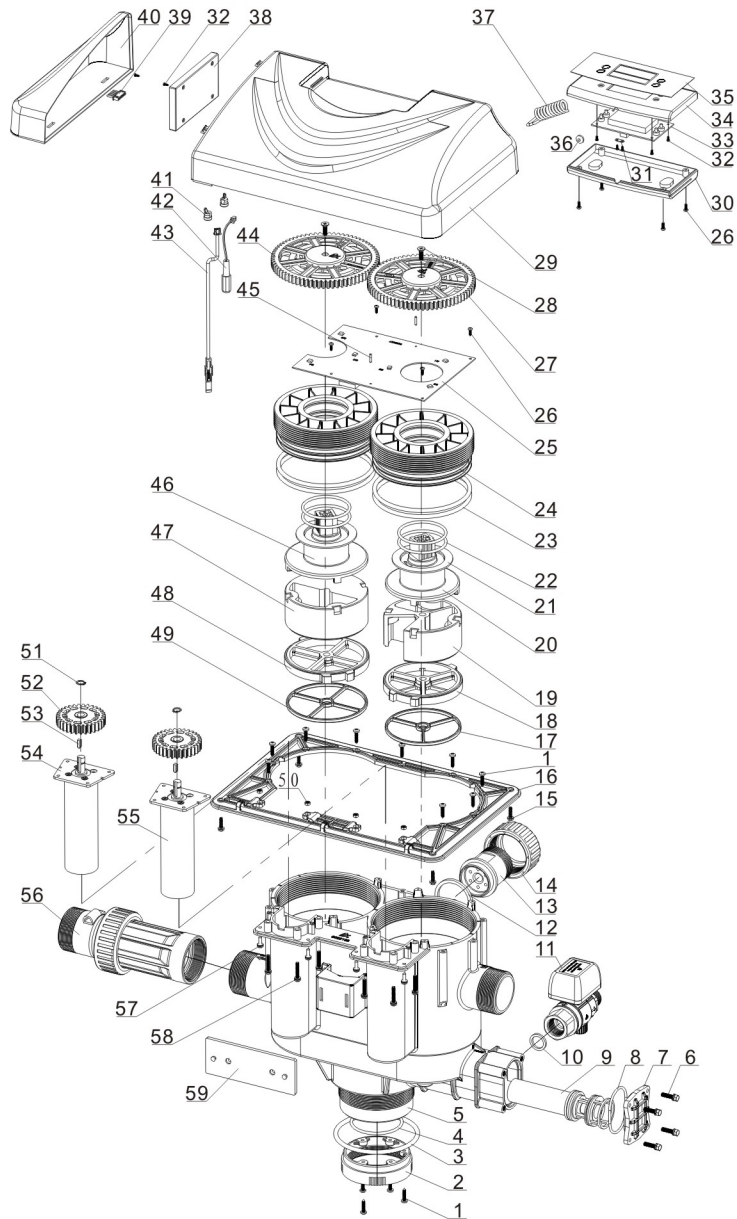

63620 Valve Body Components and Part No.:

Item No.	Description	Part No.	Quantity	Item No.	Description	Part No.	Quantity
1	Screw, Cross St3. 9X19	8909003	13	31	Cable Clip	8126001	1
2	Connector	8458018	1	32	Screw, Cross ST2.2X6.5	8909004	8
3	O-ring 104.6X5.7	8378146	1	33	Display Board	6381007	1
4	O-ring 63X3.55	8378163	1	34	Board Front Cover	8300013	1
5	Valve Body	5022085	1	35	Sticker	8865011	1
6	Hexagonal Bolt Set M5×20	5851006	4	36	Bushings	8126006	1
7	Injector Cover	8315007	1	37	Three-core Spring	5517001	1
8	O-ring 52X3	8378096	1	38	Control Board	6382049	1
9	Injector	5468020	1	39	Wire for Locating Board	5511016	1
10	Seal Ring	8371019	1	40	Front Cover	8300032	1
11	Electronic Ball Valve	2976064	1	41	Toggle	8126004	2
12	Seal Ring	8371008	1	42	Wire for Power	5513001	1
13	Flow Control	8468049	1	43	Probe Wire	6386010	1
14	Animated Connector	8947005	1	44	Gear	5241018	1
15	Hexagonal Bolt ST3.9X16	8909016	4	45	Pin 2.5X12	8993004	2
16	Junction Plate	8152019	1	46	Shaft	8258027	1
17	Seal Ring	8370078	1	47	Moving Disk	8459072	1
18	Fixed Disk	8469072	1	48	Fixed Disk	8469074	1
19	Moving Disk	8459071	1	49	Seal Ring	8370079	1
20	Shaft	8258005	1	50	Hexagonal Nut	8940002	4
21	Anti-friction Washer	8216006	2	51	Locking Ring	8994009	2
22	O-ring 59.92X3.53	8378110	4	52	Small Gear	8241008	2
23	O-ring 123.19X5.33	8378161	4	53	Pin 2.5X12	8971001	2
24	Pressure Nut	8092035	2	54	Motor	6158039	1

25	Locating Board	6380027	1	55	Motor	6158038	1
26	Screw, Cross ST2.9X9.5	8909008	12	56	Flow Meter	5447003	1
27	Gear	5241017	1	57	Screw, Cross Set M4×12	8902005	4
28	Screw, Cross ST4.8X19	8909018	2	58	Screw, Cross M4X25	8902008	8
29	Dust Cover	8005037	1	59	Display Shelf	8040003	1
30	Board Back Cover	8315008	1				

Note:

63520 there are no item 43, 56 compared to 63620.

53620 there are no item 10, 11 compared to 63620, but increase one piece seal ring 8371019 and one piece blind nut 8940004.

53520 there are no item 10, 11, 43, 56 compared to 63620, but increase one piece seal ring 8371019 and one piece blind nut 8940004.

5447003 Flow meter structure:

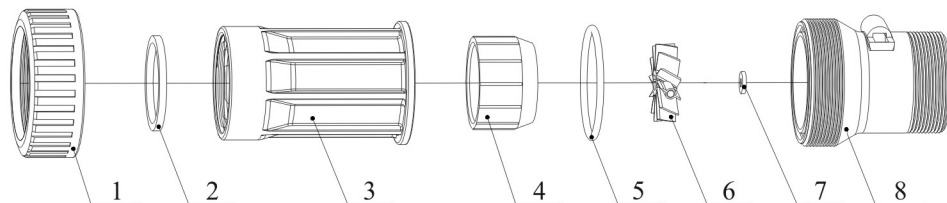

5447003 Flow Meter Components and Part No.:

Item No.	Description	Part No.	Quantity
1	Animated Connector	8947004	1
2	Seal Ring	8371008	1
3	Connector	8458016	1
4	Fixed Connector	8109006	1
5	O-ring 60X4	8378137	1
6	Turbine	5436005	1
7	Bush	8210002	1
8	Flow Meter Shell	5002002	1

4. Warranty Card

Dear client:

This warranty card is the guarantee proof of RUNXIN brand multi-functional flow control valve. It is kept by client self. You could get the after-sales services from the supplier which is appointed by RUNXIN manufacturer. Please keep it properly. It couldn't be retrieved if lost. It couldn't be repaired free of charge under the below conditions:

1. Guarantee period expired. (One year)
2. Damage resulting from using, maintenance, and keeping that are not in accordance with the instruction.
3. Damage resulting from repairing not by the appointed maintenance personnel.
4. Content in guarantee proof is unconfirmed with the label on the real good or be altered.
5. Damage resulting from force majeure.

Product Name	Multi-functional Flow Control Valve for Water Treatment Systems		
Model		Code of Valve Body	
Purchase Company Name		Tel/Cel.	
Problem			
Solution			
Date of Repairing		Date of Examination	
		Maintenance Man Signature	

When product need warranty service, please fill in the below content and sent this card together with the product to the appointed suppliers or Runxin company.

End-user Company Name		Tel/Cel.	
Purchase Company Name		Tel/Cel.	
Model	Code of Valve Body		
Tank Size φ ×	Resin Tank Size L	Raw Water Hardness mmol/L	
Water Source: Ground-water <input type="checkbox"/> Tap Water <input type="checkbox"/>	Water Treatment Capacity m³	Backwash Time min	
Brine & Slow Rinse Time min	Brine Refill Time min	Fast Rinse Time min	
Problem Description			