



International Patent No.: WO 2006/007772  
China Patent No.: ZL02220153.X,  
ZL200420078956.5  
American Patent No.: 7549446  
Indian Patent No.: 232582  
Russian Patent No.: 2349819  
South Korea Patent No.: 10-0914137  
Mexico Patent No.: 268581  
Australian Patent No.: 2005263257  
Philippine Patent No.: 1-2006-502553  
Taiwan Patent No.: M287896

## Multi-functional Flow Control Valve for Water Treatment Systems

73605(Old Model No.:F92A)

73605B(Old Model No.:F92B )

73605/41206L(Old Model No.:F92A/F70EL)

73605B/41206L(Old Model No.:F92B/F70EL)

## Instruction Manual

Please read this manual in details  
before using this valve and keep it properly  
in order to consult in the future

0WRX.466.543



## MODEL:73605 73605B 73605/41206L 73605B/41206L

Before the valve put into use, please fill in the below content so as to help us to refer in the future.

### Softener System Configuration

Tank Size: Dia. \_\_\_\_\_mm, Height\_\_\_\_\_mm;

Resin Volume \_\_\_\_\_L; Brine Tank Capacity\_\_\_\_\_L;

Hardness of Raw water\_\_\_\_\_mmol/L;

Pressure of Inlet Water\_\_\_\_\_MPa;

Control Valve Model\_\_\_\_\_ ; Number \_\_\_\_\_ ;

The Specification of Brine Line Flow Control\_\_\_\_\_;

Injector No.\_\_\_\_\_.

Water Source: Ground-water Filtered Ground-water Tap Water  Other\_\_\_\_\_.

### Parameter Set

Parameter	Unit	Factory Default	Actual Value
On-line Program	/	C-01(Interlock Program)	
Data Clear	/	d-01 ( Close )	
Control Mode A-01/02/03/04/05/06	/	A-01	
Water Treatment Capacity(A-01/02/03/04/05)	m <sup>3</sup>	50.00m <sup>3</sup>	
Regeneration Start-up Time (A-01/03/05)	/	02 : 00	
Operation Days(A-06)	D.	03	
Regeneration Factor (A-03/04)	/	0.65	
Resin Volume (A-03/04)	L.	20	
Raw Water Hardness(A-03/04)	mmol/L	1.2	
Backwash Interval Times	/	F-00	
Backwash Time	min:sec	10:00	
Brine & Slow Rinse Time	min:sec	60:00	
Fast Rinse Time	min:sec	10:00	
Brine Tank Refill Time	min:sec	05:00	
Interval Regeneration Days	D.	30	
Output Mode b-01(02)	/	b-01	

● If there is no special requirement when product purchase, we choose 8468062 drain line flow control and 8468055 brine line flow control, 6309 injector for the standard configuration.

## Catalogue

Notice.....	3
1. Product Overview.....	4
1.1. Main Application & Applicability.....	4
1.2. Product Characteristics.....	4
1.3. Service Condition.....	6
1.4. Product Structure and Technical Parameters.....	7
1.5. Installation.....	8
2. Basic Setting & Usage.....	10
2.1. The Function of PC Board.....	10
2.2. Basic Setting & Usage.....	11
3. Application.....	14
3.1. Softener Flow Chart.....	14
3.2. The Function and Connection of PC Board.....	16
A. Signal Output.....	17
B. Interlock.....	20
C. One in Service One Standby.....	20
D. Remote Handling Input.....	21
E. Interlock System.....	21
F. Series System.....	21
3.3. System Configuration and Flow Rate Curve.....	22
3.4. Parameter Settlement.....	24
3.5. Parameter Enquiry and Setting.....	25
3.6. Trial Running.....	29
3.7. Trouble-Shooting.....	31
3.8. Spare Part and Part No.....	35
4. Warranty Card.....	41

## Notice

- To ensure normal operation of the valve, please consult with professional installation or repairing personnel before use it.
- If there are any of pipeline engineering and electric works, there must be finished by professional at the time of installation.
- Do not use the control valve with the water that is unsafe or unknown quality.
- Depending on the changing of working environment and water requirement, each parameter of softener should be adjusted accordingly.
- When the water treatment capacity is too low, please check the resin. If the reason is shortage of resin, please add; if the resin is turn to reddish brown or broken, please replace.
- Test water periodically to verify that system is performing satisfactorily.
- Sodium used in the water softening process should be considered as part your overall dietary salt intake. Contact doctor if you are on a low sodium diet.
- Ensure that there is solid salt all the time in the brine tank in the course of using, when this valve is used for softening. The brine tank should be added the clean water softening salts only, at least 99.5% pure, forbidding use the small salt.
- Do not put the valve near the hot resource, high humidity, corrosive, intense magnetic field or intense librations environment. And do not leave it outside.
- Forbidden to carry the injector body. Avoid using injector body as support to carry the system.
- Forbidden to use the brine tube or other connectors as support to carry the system.
- Please use this product under the water temperature between 5~50 °C, water pressure 0.15~0.6MPa. Failure to use this product under such conditions voids the warranty.
- If the water pressure exceeds 0.6Mpa, a pressure reducing valve must be installed before the water inlet. While, if the water pressure under 0.15MPa, a booster pump must be installed before the water inlet.
- It is suggested to install PPR pipe, corrugated pipe or UPVC pipe, instead of TTLSG pipe.
- Do not let children touch or play, because carelessness operating may cause the procedure changed.
- When the attached cables of this product and transformer are changed, they must be changed to the one that is from our factory.

## 1.Product Overview

### 1.1.Main Application & Applicability

Used for softening or demineralization water treatment systems.

Be suitable for

- Residential softening system
- Ion exchange equipment
- Boiler softening water system
- RO pretreatment softening system, etc.

### 1.2.Product Characteristics

#### ➤Simple structure and reliable sealing

It adopts hermetic head faces with high degree pottery and corrosion resistance for opening and closing. It combines with Service, Backwash, Brine & Slow Rinse, Brine Refill and Fast Rinse.

#### ➤Up-flow Regeneration

Up-flow regeneration, salt and water savings. No hard water pass and hard water pass options.

#### ➤Soft Water Refill

System also in service when in brine tank refill (Means soft water flows in outlet), save the regeneration time and regenerate more efficient.

#### ➤Big Water Flow Rate

Flow Rate will be not lower 4.7m<sup>3</sup>/h when pressure drop is 0.1MPa.

#### ➤Historical Record can be Enquired

Can enquiry soft edition, maximum flow rate after being used, totally using days, regeneration times after being used and all data records can be clear.



#### ➤Manual function

Realize regeneration immediately by pushing manual button  at any time.



#### ➤Long outage indicator

If outage overrides 3days, the time of day indicator 12:12 will flash to remind people to reset new time of day. The other set parameters do not need to reset. The process will continue to work after power on.

#### ➤Buttons lock

No operations to buttons on the controller within 1 minute, button lock indicator light on which represent buttons are locked. Before operation press and hold the  and  buttons for 3 seconds to unlock. This function can avoid incorrect operation.

#### ➤Technician or manufacturers can choose regeneration control mode via getting authority.

When control valve get connected with power, press button ,  and  orderly to enter into enquiry and set menu which is available for technician or manufacture. Six

control mode listed in table one can be chose in regeneration control mode menu.

Mode	Name	Instruction
A-01	Meter Delayed	Regenerate on the day although the available volume of treated water drops to zero (0). Regeneration starts at the regeneration time.
A-02	Meter Immediate	Regenerate immediately when the available volume of treated water drops to zero(0).
A-03	Intelligent Meter Delayed	Meter Delayed Regeneration type, but by setting Resin Volume, Feed Water Hardness, Regeneration Factor, the controller will calculate the System Capacity.
A-04	Intelligent Meter Immediate	Meter Immediately Regeneration Type, but by setting Resin Volume, Feed Water Hardness, Regeneration Factor, the controller will calculate the System Capacity.
A-05	Surplus Water Comparing	When the available volume of treated water not more than average day water capacity of previous 7 days, regeneration starts at the regeneration time.
A-06	Time Type by Day	Service days count down to zero(0), regeneration stars at the regeneration time.

➤**Signal output**

There is a signal output connector on main control board. It is for controlling external wiring. (Refer to Figure7 to Figure 13).

There are two kinds of output modes. b-01 Mode: Turn on start of regeneration and shut off end of regeneration; b-02 Mode: Signal available only intervals of regeneration cycles (Motor running moment).(Regeneration sequence 1 as example), show as following:

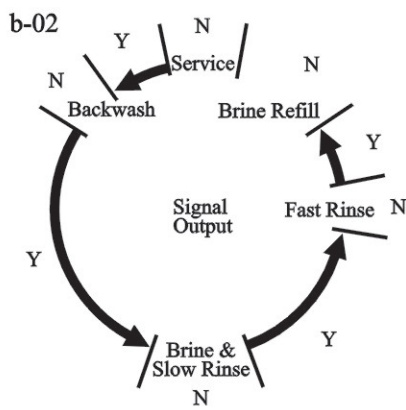
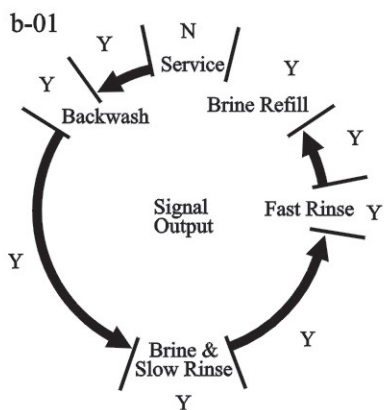

➤**Interlock function**

Set program function of “Interlock c-01” to realize only one valve in regeneration but the other valves are in service while several valves parallel or series connection in system. (Application refer to Figure 14)

➤ **One in service one standby**

Set program function of “One in service one standby” to realize continuously water supply while the outlet of two valves connected with Runxin specialized tee valve, this is called one in service one standby. (Application refer to Figure 15)

➤ **Remote Handling Connector**

This connector can receive 5~24VDC external signal, used together with PLC, and computer etc. to control the valve remotely. (Application refer to Figure 16)

➤ **Maximum interval regeneration days (Not available for A-06)**

Under the situation of service reaching the setting days and the volume not yet, it could enter into regeneration process forcibly when current time is the same as regeneration time.

➤ **All parameters can be modified**

According to the water quality and usage, the parameters in the process can be adjusted.

**1.3.Using condition**

Valve should be used under the below conditions

Item		Requirement
Working conditions	Working pressure	0.15MPa ~ 0.6MPa
	Water temperature	5℃ ~ 50℃
Working environment	Environment temperature	5℃ ~ 50℃
	Relative humidity	≤95% ( 25℃ )
	Electrical Facility	AC100 ~ 240V/50 ~ 60Hz
Inlet water quality	Water turbidity	Up-flow regeneration < 2FTU
	Water hardness	First Grade Na+ < 6.5mmol/L; Second Grade Na+ < 10mmol/L
	Free chlorine	< 0.1mg/L
	Iron <sup>2+</sup>	< 0.3mg/L
	CODMn	< 2mg/L ( O <sub>2</sub> )

In the above table, First Grade Na+ represents First Grade Na+ Exchanger. Second Grade Na+ represents Second Grade Na+ Exchanger.

- When the water turbidity exceeds the conditions, a filter should be installed on the inlet of control valve.
- When the water hardness exceeds the conditions, the outlet water hardness will hardly reach the requirement of boiler feed water ( 0.03 mmol/L ) . It is suggested to adopt second grade softener.

## MODEL:73605 73605B 73605/41206L 73605B/41206L

### 1.4.Product Structure and Technical Parameters

The appearance is just for reference.

It is subjected to the real product.

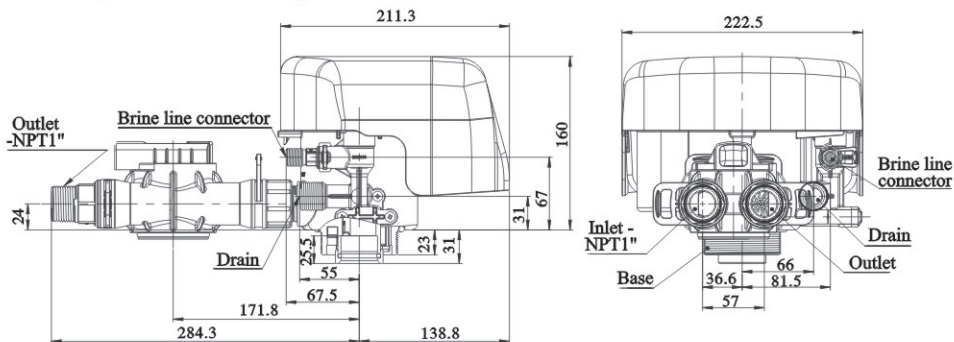

**Connect Port Dimensions**

Product Model	Bypass or Flow Meter	Inlet Port	Outlet Port	Drain Port	Brine Port	Base	Riser Pipe	Hard Water Bypass
73605	Flow Meter 5447007	G1"	G1"	NPT3/4"	G3/8"	2.5" -8NPSM	1" D-GB (φ32)	No
73605B	Flow Meter 5447007	G1"	G1"	NPT3/4"	G3/8"	2.5" -8NPSM	1" D-GB (φ32)	Yes
73605/41602L	Bypass 41602L	NPT1"	NPT1"	NPT3/4"	G3/8"	2.5" -8NPSM	1" D-GB (φ32)	No
73605B/41602L	Bypass 41602L	NPT1"	NPT1"	NPT3/4"	G3/8"	2.5" -8NPSM	1" D-GB (φ32)	Yes

**Main Technical Parameters**

Water Capacity m <sup>3</sup> /h	4.7(0.1Mpa Pressure Drop)
Power Input	AC100 ~ 240V/50 ~ 60Hz
Power Output	DC12V, 2.0A

Regeneration Mode	<p>A-01 Meter Delay: Regeneration happens when the capacity reaches to zero and the preset time of regeneration is reached.</p> <p>A-02 Meter Immediate: Regeneration happens when the capacity reaches to zero.</p> <p>A-03 Intelligent Meter Delay: The same delay function as A-01 but the capacity is set by input of the Resin Volume and Feed Water Hardness. The Control valve calculates the gallons before regeneration.</p> <p>A-04 Intelligent Meter Immediate: The same delay function as A-02 but the capacity is set by inputting the Resin Volume and Feed Water Hardness. The Control valve calculates the gallons before regeneration.</p> <p>A-05 Surplus Water Comparing: When the surplus water capacity less than previous 7 days daily using, and current time reaches to preset time of regeneration, regenerate happens.</p> <p>A-06 Time type by day: Service days count down to zero (0), regeneration stars at the regeneration time.</p>
-------------------	--



## 1.5. Installation

### A. Installation notice

Before installation, read all those instructions completely. Then obtain all materials and tools needed for installation.

The installation of product, pipes and circuits, should be accomplished by professional to ensure the product can operate normally.

Perform installation according to the relative pipeline regulations and the specification of Water Inlet, Water Outlet, Drain Outlet, and Brine Line Connector.

### B. Device location

- ① The filter or softener should be located close to drain.
- ② Ensure the unit is installed in enough space for operating and maintenance.
- ③ Brine tank need to be close to softener.
- ④ The unit should be kept away the heater, and not be exposed outdoor. Sunshine or rain will cause the system damage.
- ⑤ Please avoid to install the system in one Acid/Alkaline, Magnetic or strong vibration circumstance, because above factors will cause the system disorder.
- ⑥ Do not install the filter or softener, drain pipeline in circumstance which temperature may drop below 5°C, or above 50°C.
- ⑦ One place is recommended to install the system which causes the minimum loss in case of water leaking.

### C. Pipeline installation

#### ① Install control valve

a. As the Figure 1-1 shows, select the riser pipe with 32mm OD, glue the riser pipe to the bottom strainer and put it into the mineral tank, cut off the exceeding tube out of tank top opening. Plug the riser tube in case of mineral entering.

Fill the mineral to the tank, and the height is accordance with the design code.

b. Install the top distributor to the valve.

c. Insert the riser tube into control valve and screw tight control valve.

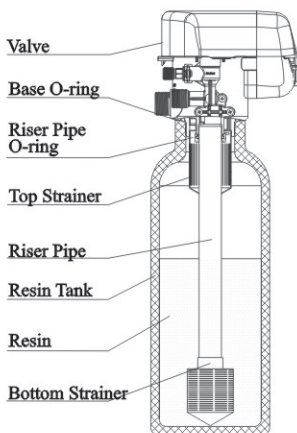

Figure 1

#### Note:

- The length of riser tube should not be lower 15mm than tank top opening height, lower than 8mm is advisable, and its top end should be rounded to avoid damage of O-ring inside the valve.
- Avoid floccules substance together with resin to be filled in the mineral tank.
- Avoid O-ring inside control valve falling out while rotating it on the tank.

② Install bypass valve

As figure 2 shows, put the sealing ring into nut of animated connector, and screw in water inlet and outlet.

Insert animated connector to bypass valve then insert in buckle.

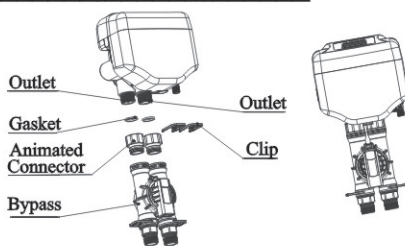

Figure 2

③ Pipeline connection

As figure 3 shows, inlet pipe connect with inlet connector of bypass via 1" NPT female connector.

Outlet pipe connect with outlet pipe of bypass via 1" NPT female connector.

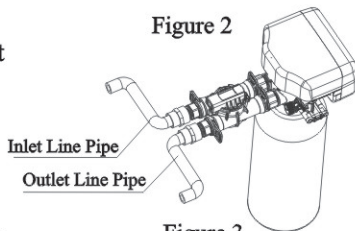

Figure 3

④ Install drain pipeline

a. As the Figure 4 shows, Insert drain line flow control into drain outlet.

b. Insert O-ring into O-ring slot of drain connector.

c. Insert drain hose connector into drain outlet.

d. Screw drain hose connector into drain outlet, and lock it.

e. Locate the drain hose well as the Figure4 show.

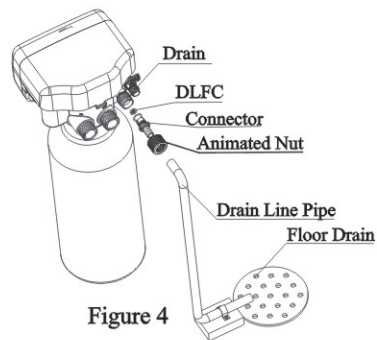

Figure 4

Notice

● Drain line pipe lower than valve is advisable, if the drain line pipe higher 2m than valve is permitted, and the pipe should not longer then 3m. Pipe too high or too long both will impact brine.

● Be sure not connect drain with sewer, and leave a certain space between them, avoid wastewater be absorbing to the water treatment equipment, such as showed in the Figure4.

⑤ Connect brine tube

a. As Figure5 shows, slide 3/8" brine tube hose connector over end of brine tube.

b. Insert the filter net into the tube.

c. Insert tube bushing into the end of brine tube.

d. Tighten brine draw hose connector onto brine line connector.

e. Connect the other end of brine tube with the brine tank. (The liquid level controller and air-blocker should be installed in the brine tank.)

Remark: The brine tube and drain pipeline should not be bended or plugged.

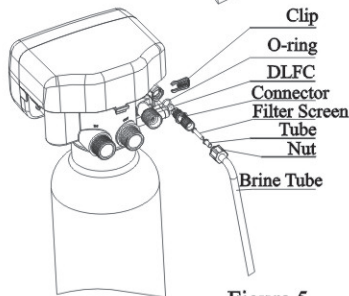
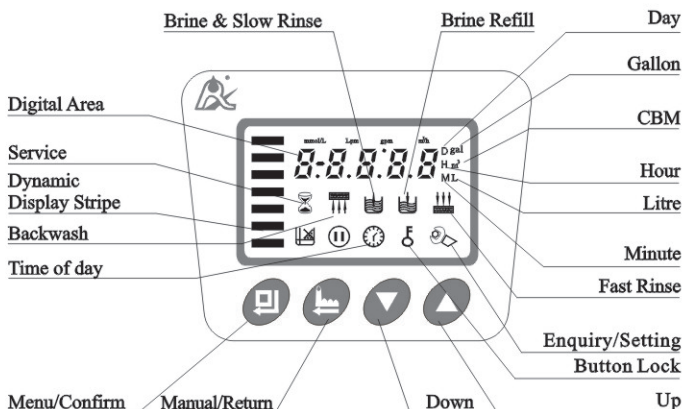

Figure 5









## 2.Basic Setting & Usage

### 2.1.The Function of PC Board









- A. Time of day indicator.  
 Lights on, the data indicates current time.
- B. Button lock indicator.  
 ● Lights on, indicate the buttons are locked. At this moment, press any single button will not work (no operation in one minute, will light on and lock the buttons.)  
 ●Solution: Press and hold both and for 3 seconds until the lights off.
- C. Program Mode indicator  
 ● lights on, indicate the enquiry status, press or can enquiry all parameters.  
 ● flashes, indicate the setting status, press or could change all parameters.
- D. Manu/Confirm button  
 ●Press , lights on, enter program display mode and use or to view all values.  
 ●In program display mode, press , flashes, enter program set mode, press or and adjust values.  
 ●Press after all program are set, and then the voice “Di” means all setting are success and return program display mode.
- E. Manual/Return button  
 ●Press in any status, it can proceed to next step.(Example: Press in Service status, it will start regeneration cycles instantly; Press while it is in Backwash status, it will end backwash and go to Brine & Slow Rinse at once.)  
 ●Press in program display mode, and it will return in Service; Press in program set mode, and it will return program display mode.  
 ●Press while adjusting the value, then it will return program display mode directly without saving value.

F.Down  and Up 

- In menu mode, press  or  to page up or page down all setting entries.
- In program set mode, press  or  to adjust values.
- Press and hold both  and  for 3 seconds to lift the Button Lock status.
- Press  when in parameter setting status or historical data record enquiry status can back to enquiry status, then press  again can back to working status.
- Press  when in change parameters status, all the changes will not be saved and program back to enquiry status.

## 2.2. Basic Setting & Usage

### A. Parameter specification available to terminal user

Function	Indicate	Factory Default	Parameter set range	Instruction
Time of day		Random	00:00 ~ 23:59	Set the time to be current time, 24 hours type
Water Treatment Capacity		50m <sup>3</sup>	0 ~ 999.99 m <sup>3</sup>	Water Treatment Capacity for one operation cycle (m <sup>3</sup> )
Regeneration Time	02:00	02:00	00:00 ~ 23:59	Time when regenerate happens,
Exchange Factor	AL.65	0.65	0.30 ~ 0.99	Matter with raw water hardness, the higher the hardness is, the lower of exchange factor
Resin Volume	20L	20L	5 ~ 500L	Resin volume in tank (L)
Raw Water Hardness	Yd1.2	1.2	0.1 ~ 9.9	Inlet water hardness (mmol/L)
Interval Backwash Times	F-00	F-00	0 ~ 20	Whether need backwash in every operation cycle
Backwash		60:00	0 ~ 99:59	Backwash Time (Min :Second)
Brine & Slow rinse		10:00	0 ~ 99:59	Brine & Slow rinses time (Min :Second)
Fast rinse		05:00	0 ~ 99:59	Fast rinse time (Min :Second)
Brine Refill		1-03D	0 ~ 99:59	Brine refill time (Min :Second)
Service Days		30	0 ~ 99 days	Only available for time type by day
Maximum Interval Regeneration Days	H-30	10:00	0 ~ 40	Regenerate on the day even through the available volume of treated water does not drop to zero (Available for A-01/02/03/04/05 ).

MODEL:73605 73605B 73605/41206L 73605B/41206L

Enquiry Historical Record	Maximum flow rate in previous seven days	X.XX m <sup>3</sup> /h	/	/	Enquiry the maximum flow rate in previous seven days
	Regenerated times	XX	/	/	Enquiry the automatic regenerated times (Manual regeneration only include)
Signal Output Mode	b-01	01	01 or 02		Signal output in the regeneration process (See P5) Signal output in position turning Time (See P5)

**B.Parameter specification available to technician and factory.**

Function	Indication	Factory Default	Parameter set range	Instruction
On-line Program	C-01	C-01	C-01/02	C-01: Interlock C-02: One in service one standby
Data Reset	d-01	d-01	d-01/02	d-01=Data record d-02= Data reset
Control Mode	A-01	A-01	A-01	Meter Delayed: Regenerate on the day although the available volume of treated water drops to zero (0). Regeneration starts at the regeneration time.
			A-02	Meter Immediate: Regenerate immediately when the available volume of treated water drops to zero(0).
			A-03	Intelligent Meter Delayed: Meter Delayed Regeneration type, but by setting Resin Volume, Feed Water Hardness, Regeneration Factor, the controller will calculate the System Capacity.
			A-04	Intelligent Meter Immediate: Meter Immediately Regeneration Type, but by setting Resin Volume, Feed Water Hardness, Regeneration Factor, the controller will calculate the System Capacity.
			A-05	Surplus Water Comparing: When the available volume of treated water not more than average day water capacity of previous 7 days, regeneration starts at the regeneration time.
			A-06	Time Type by Day: Service days count down to zero(0),regeneration stars at the regeneration time.
Unitof Capacity	m <sup>3</sup>	HU-01	HU-01/02/03	02=gal, 03=L

**C.Process Display**



Figure A



Figure B



Figure C



Figure D

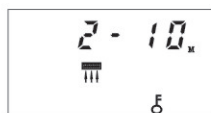

Figure E



Figure F

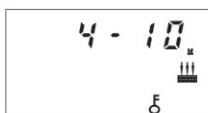

Figure G

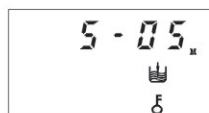



Figure H











Illustration:











- The figure shows A,B,C and D repeatedly in service status. When in backwash status, shows E and C, in brine & slow rinse shows figure F and C. In fast rinse shows figure G and C. In brine refill shows figure H and C. Every figure will display 15 seconds.
- Figure A suits for control mode A-01/03/05. For A-02/04, it will not show regeneration time when in service. For A-06 the display data is service days when in service position.
- Screen showing “-00-” only when motor running.
- When the clock symbol flashes, like “12:12” flashes, it indicates long time power outage and reminds to reset the time.
- When system failure, screen shows error code, like “-E1-”.
- Working process: service→backwash→brine→fast rinse→back to service.

D. Usage

After being accomplished installation, parameter setting and trail running, the valve could be put into use. In order to ensure the quality of outlet water can reach the requirement, the user should complete the below works:

- ① Ensure that there is solid salt all the time in the brine tank in the course of using when this valve is used for softening. The brine tank should be added the clean water softening salts only, at least 99.5% pure, forbidding use the small salt and iodized salt.
- ② Test the outlet water and raw water hardness at regular time. When the outlet water hardness is unqualified, please press the  and the valve will temporary regenerate again( it will not affect the original set operation cycle)
- ③ When the feed water hardness change a lot, you can adjust the water treatment capacity as follow:

For control mode as A-01/03/05: Press and hold both  and  for 5 seconds to lift the lock status. Press , then press  or  to select “set water treatment capacity”, press  and digits flashes. Press  and  continuously, reset the capacity value. Press  and hear a sound “Di”, then finish the adjustment. Press  exit and turn back the service status.

For control mode A-03/04: Press and hold both  and  for 5 seconds to lift the lock status. Press , then press  or  to select “set raw water hardness”, press  and digits flashes. Press  and  continuously, reset the raw water hardness value. Press  and hear a sound “Di”, then finish the adjustment. Press  exit and turn back the service status.

When select A-03 or A-04 control mode, the control will automatically calculate the water treatment capacity by setting resin volume, feed water hardness and regeneration factor.

The regeneration parameters have been set when control valve left factory. Generally, it does not need to reset. If you want enquiry and modify the setting, you can refer to the professional application specification.

### 3.Applications

#### 3.1. Softener Flow Chart

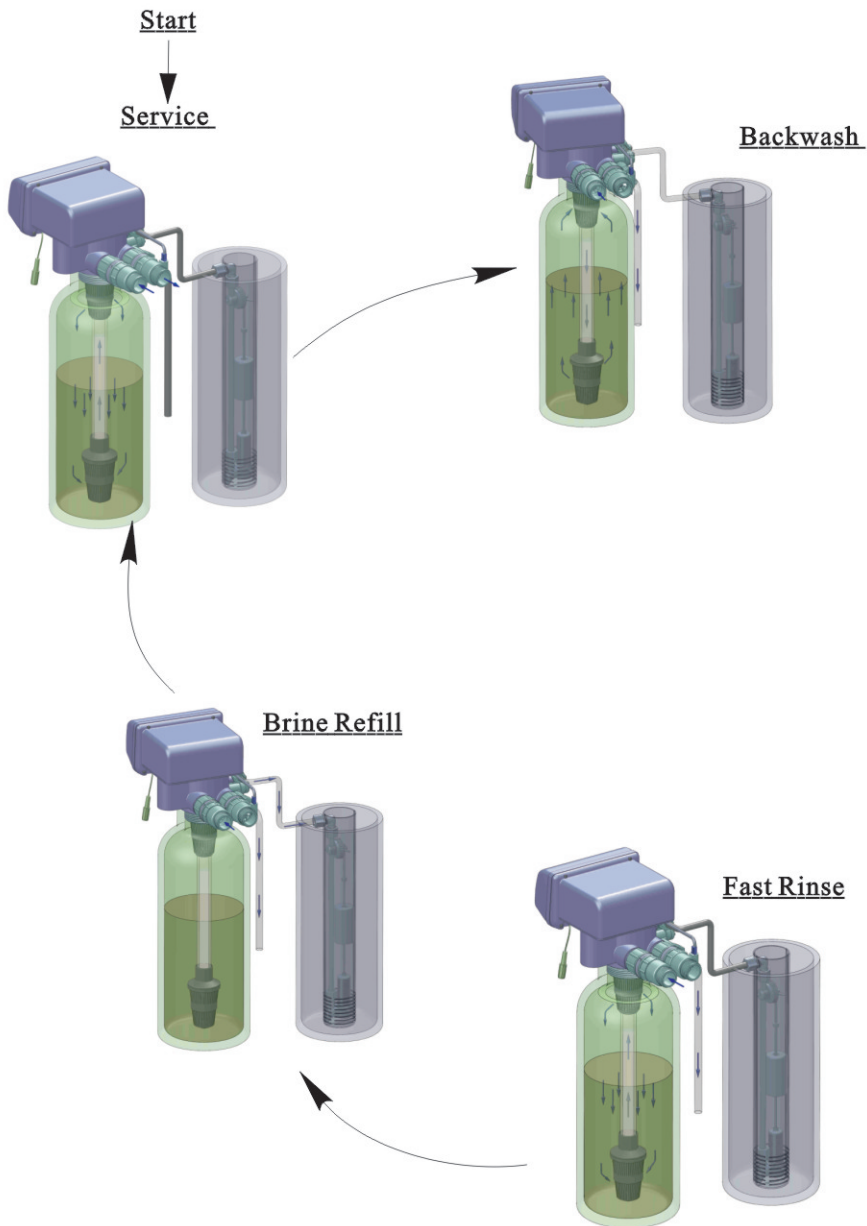

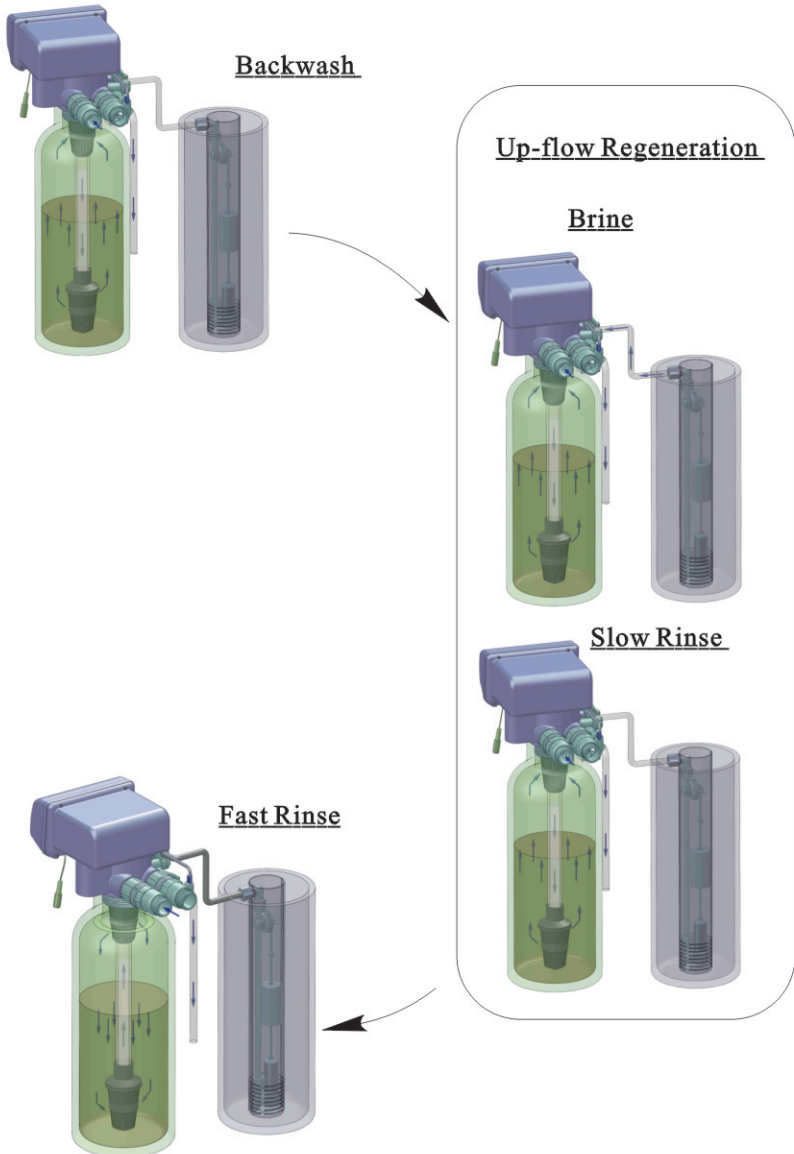



### 3.2. The Function and Connection of PC Board

Open the front cover of control valve, you will see the main control board and connection port as below:

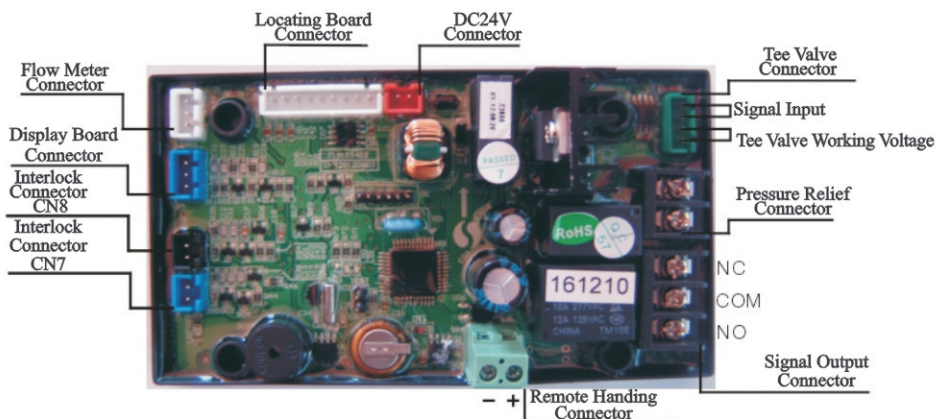

Figure 6

The main functions on main control board:

Function	Application	Explanation
Signal output connector b-01	Outlet solenoid valve	If system strictly require no hard water flow from outlet or controlling the liquid level in water tank.
	Inlet pump	Increase pressure for regeneration or washing. Use the liquid level controller to control inlet pump to ensure there is water in tank.
Signal output connector b-02	Inlet solenoid valve or inlet pump	When inlet pressure is high, it needs to close water inlet when valve is rotating to protect motor.
Tee valve connector	Connect with tee valve to control outlet port	When both two valves are set one in service one standby program, use tee valve will make one valve supplying water while another one standby when both valves are in service status.
Interlock connector	To ensure not more than one control valve regeneration or washing in system.	Use in RO Pre-treatment, water supply together but regeneration in turn. Second grade ion exchange equipment, etc.
Remote handling connector	Receipt signal to make the control rotate to next circle	It is used for on-line inspection system, PC connection, and realize automatically or remote controlling valve.

### A. Signal Output Connector

#### 1) Control Solenoid Valve(Set b-01)

##### ①Solenoid Valve on Outlet Controls Water Level in Brine Tank.

Instruction: If system strictly require no hard water flow from outlet in regeneration cycle ( Mainly for no hard water flow out when valve is switching or valve in backwash or brine drawing positions), a solenoid valve could be installed on outlet, the wiring refer to Figure 7.

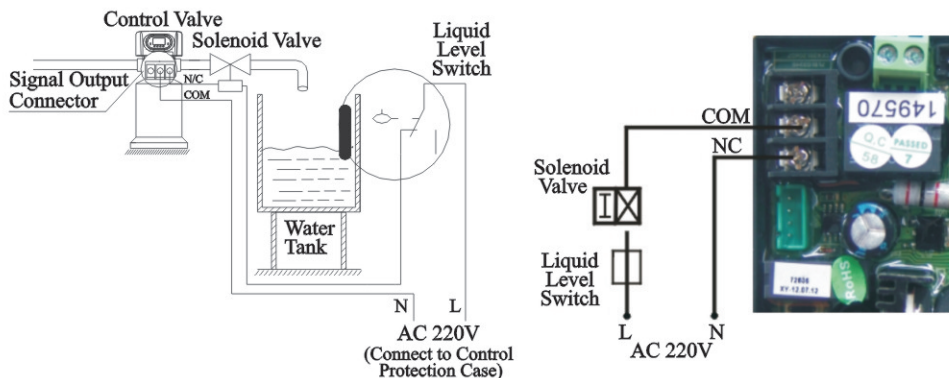

Figure 7 Wring of Solenoid Valve on Outlet

#### Function:

When valve in service status, if soft water tank is short of water, solenoid valve is open to supply soft water, but if water tank has enough water, solenoid valve is closed, so no soft water supplied.

When the valve in backwash status, no signal output. So, solenoid valve is closed, and no water flow into soft water tank.

#### ②Solenoid Valve on Inlet( Set b-02)

Instruction: When inlet pressure exceeds 0.6MPa, install a solenoid valve on inlet. Control mode is b-02. Pressure relieved when valve switching, the wiring refer to Figure8.

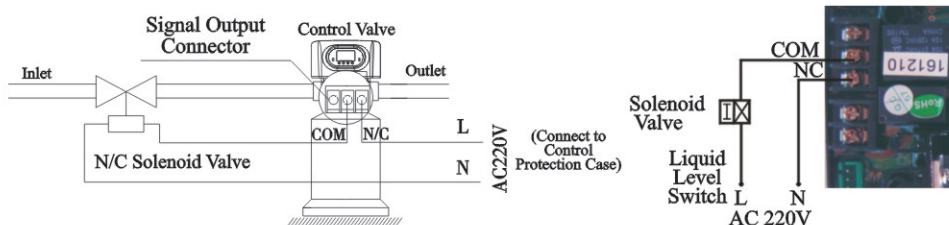

Figure8 Wiring of Solenoid Valve on Inlet

## MODEL:73605 73605B 73605/41206L 73605B/41206L

### Function:

When inlet pressure is high, install a solenoid valve on inlet to ensure valve switching properly. When valve is exactly at position of Service, Backwash, Brine& Slow Rinse, Brine Refill and Fast Rinse, solenoid valve is open. When valve is switching, solenoid valve is closed, no water flow into valve to ensure valve switching properly. It could prevent the problem of mix water and water hammer.

Use interlock cable to realize valves in parallel and series in same system which is suited for RO pretreatment system or second grade Na<sup>+</sup> system. The Wiring refer to Figure9:

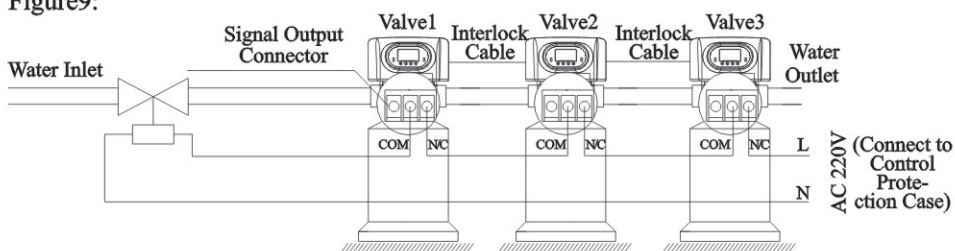

Figure 9 Wiring of Solenoid Valve in Inlet

### 2) Liquid Level Controller Controls Inlet Pump( Two-phase Motor)( Set b-01)

Instruction: For the system using well or middle-tank supplying water, switch of liquid level controller and valve together control pump opening or closing. The wiring refer to Figure10:

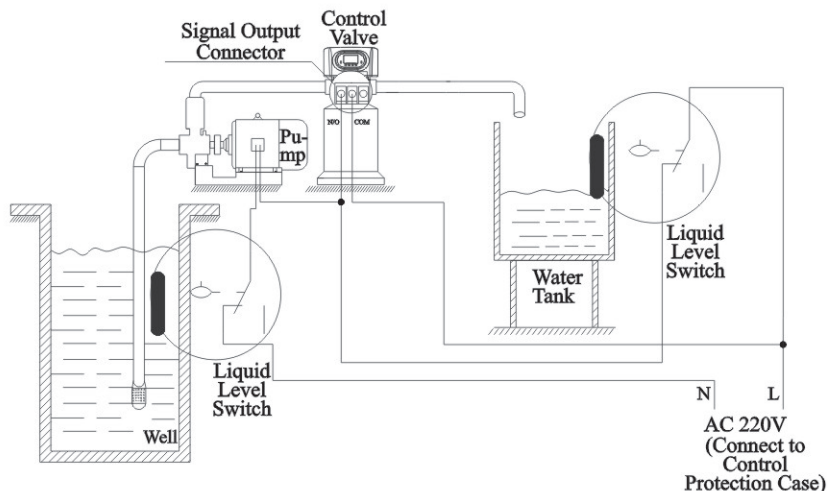

Figure 10 Wiring of Liquid Level Controller Controlling Inlet Pump

**Function:**

When valve in service status, if water tank is short of water, start up pump, but if water tank has enough water, the switch of liquid level controller is closed, so pump doesn't work.

When valve in regeneration cycle, inlet always has water no matter what is water condition in water tank. A liquid switch at the top opening of well or in middle water tank in RO system protect pump from working without water in case of out of raw water.

**3) Liquid Level Switch in Water Tank Controls Inlet pump (Three-phase,figure3-5) (set b-01)**

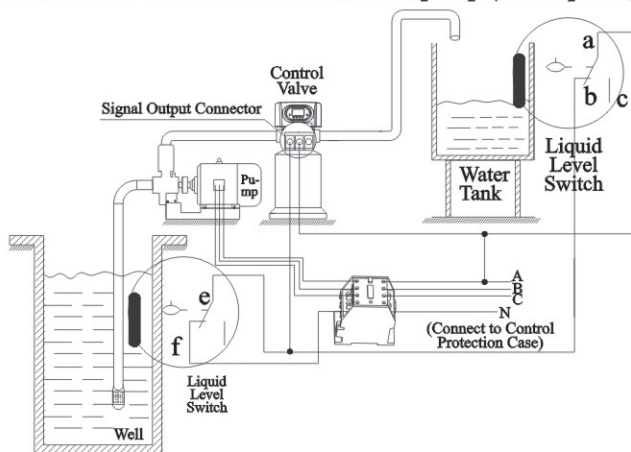

Figure11 Wiring of Liquid Level Switch in Water Tank Controls Inlet Pump

**4) Control Inlet Booster Pump( Set b-01 or b-02)**

Instruction: If inlet water pressure is less than 0.15MPa, which makes rinse drawing difficult, a booster pump is suggested to be installed on inlet. Control mode b-01. When system in regeneration cycle, booster pump is open, the wiring refer to Figure 12.If the booster pump current is bigger than 5A, system need to install an contactor, the wiring refer to Figure13

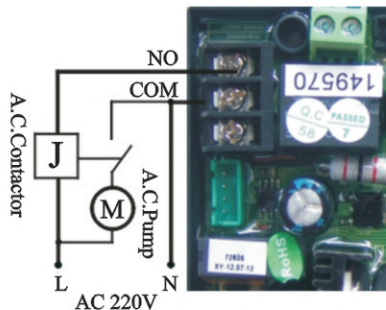
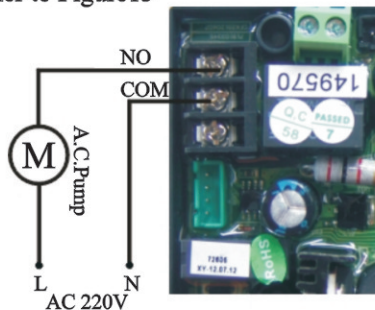

Figure12 Wiring of Booster Pump on Inlet

Figure 13 Wiring of Booster Pump on Inlet

## B. Interlock

Instruction: In the parallel water treatment system, it ensure only one valve in regeneration or washing cycle and (n-1) valves in service, that is, realizing the function of supplying water simultaneously and regenerating individually.

In the series and parallel water treatment system(Second grade Na<sup>+</sup> Exchanger or RO pre-treatment system), it ensure only one valve in regeneration or washing cycle and there is/are water(s) in service, the wiring refer to Figure14

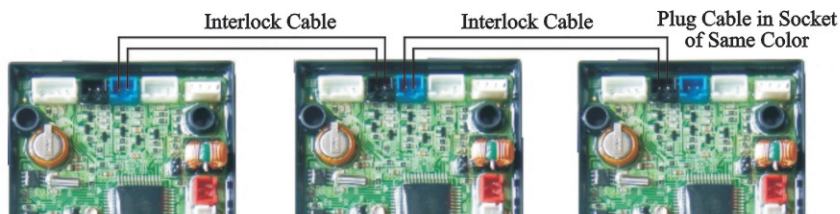

Figure14 Interlock Connect

Use Interlock Cable to connect CN8 to CN7 on next valve in the loop.

One system with several valves, if interlock cable is disconnected, the system is divided into two individual system.

## C. One in service one standby

Instruction: Use two valves supply water continuously system, it ensures there is always one valve supplying water and another is waiting or in regeneration, the wiring refer to Figure15

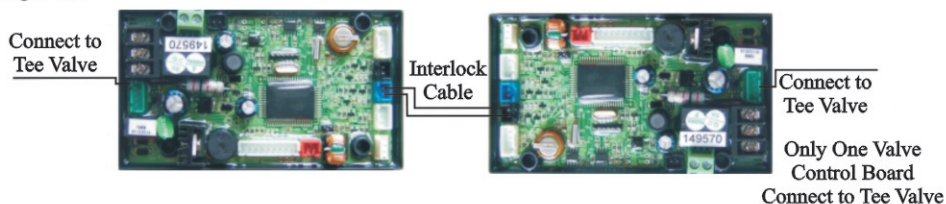

Figure15 Wiring of One in Service One Standby

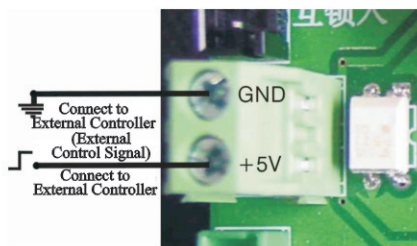

Figure16 Wiring of Remote Input

**D. Remote Handling Connector**

Online TDS meter monitors treated water other than a flow meter, or PLC controls the regeneration time. When the controller receives a contact closure from above instruments, regeneration begins. The wiring refers to Figure16:

**E. Interlock System**

2 or more valves are interlocked connecting in one system can be realized. The wiring refers to Figure17.

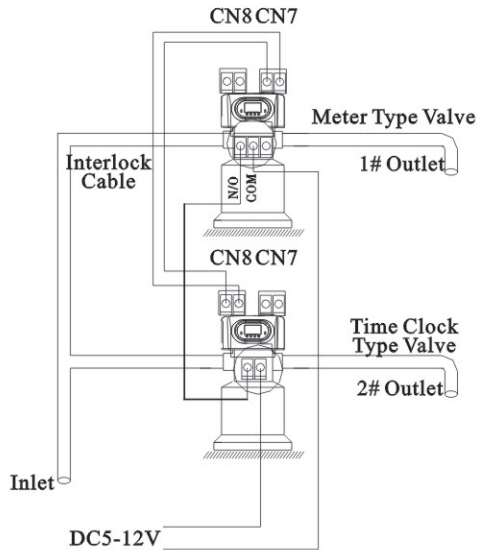
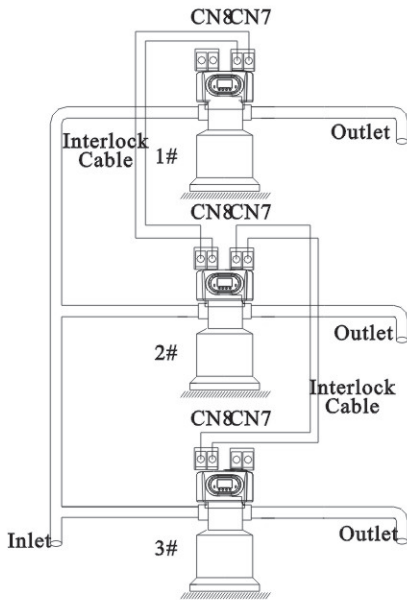

Figure17 All in service, regenerate individually

Figure18 All in service, regenerate sequence

**F. Series System**

This is a 2 or more than 2 valves system, all in service, with one flow meter for the entire system. For the time type valve, the regeneration time should be set and adjusted to the Max; for the meter type valve, connect its signal output connector with the remote handle connector of the time-type valve. That can realize the function of supplying water simultaneously and regenerating orderly. The wiring refers to Figure18:

### 3.3. System Configuration and Flow Rate Curve

#### A. Product configuration with tank, resin volume, brine tank and injector

Tank Diameter mm	Resin Volum (L)	Water Capacity (m <sup>3</sup> /h)	Brine Tank L	Minimum regeneration salt usage (Kg)	Injector Model
Φ 250 × 1390	40	1.5	100	6.0	6302
Φ 300 × 1650	60	2.0	100	9.0	6303
Φ 350 × 1650	100	2.5	200	15.0	6305
Φ 400 × 1650	125	3.5	200	18.0	6307
Φ 450 × 1650	150	4.5	300	18.7	6308
Φ 500 × 1750	200	6.0	300	30.0	6309
Φ 550 × 1750	280	7.0	500	42.0	6310

**Attention: The flow rate calculation is based on linear velocity 25m/hr; the minimum salt consumption for regeneration calculation is based on salt consumption 150g / L (Resin).**

#### B. Flow Rate Characteristic

##### Pressure-flow rate curve

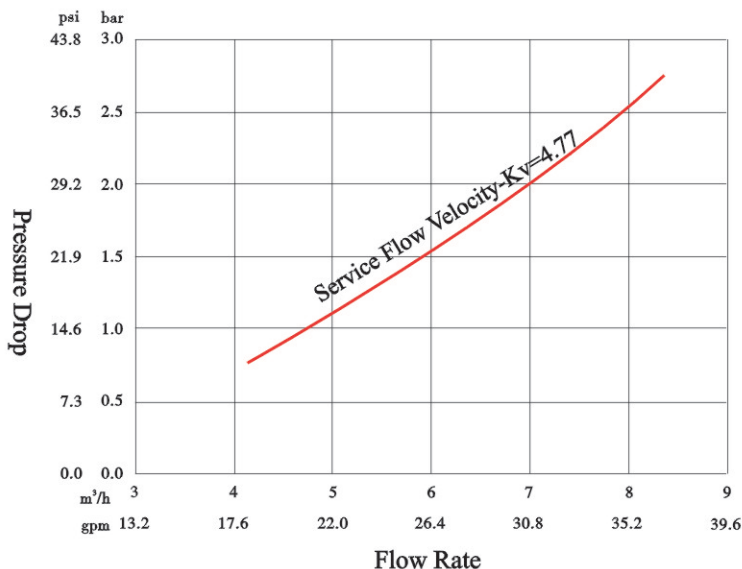

MODEL:73605 73605B 73605/41206L 73605B/41206L

2) Injector parameter table

Inlet Pressure	(L/M) Flow Rate on Injector									
	6301 Coffee	6302 Pink	6303 Yellow	6304 Blue	6305 White	6306 Black	6307 Purple	6308 Red	6309 Green	6310 (see remark)
0.15	1.19	1.5	2.25	2.86	3.21	3.88	4.08	4.38	5.55	6.20
0.20	1.38	1.75	2.6	3.3	3.8	4.46	4.73	5.18	6.61	7.00
0.25	1.58	1.93	2.87	3.62	4.21	4.95	5.28	6.2	7.3	7.90
0.30	1.72	2.11	3.17	3.99	4.58	5.19	5.76	6.72	7.68	8.65
0.35	1.84	2.26	3.35	4.28	5.05	5.48	6.15	7.23	8.45	9.22
0.40	2.46	2.4	3.58	4.6	5.35	5.71	6.45	7.52	8.8	9.65

**Remark: Injector 6310 consists of yellow nozzle and green throat.**

3). Configuration for Standard Injector and Drain Line Flow Control

Tank Dia- meter mm	Injector Model	Yellow (Nozzle/ Throat)	Total Flow Rate on Injector	Flow Rate of Slow Rinse	Part number of BLFC	Flow Rate of Brine Refill	Part Number of DLFC	Flow Rate of Backwash and Fast rinse
			L/m	L/m		L/m		L/m
175	6301	Coffee	1.72	1.04	8468057	0.83	8468043	4.31
200	6301	Coffee	1.72	1.04	8468056	1.13	8468042	7.15
225	6302	Pink	2.11	1.27	8468056	1.13	8468060	7.64
250	6302	Pink	2.11	1.27	8468052	1.47	8468061	10.82
300	6303	Yellow	3.17	1.75	8468053	3.14	8468045	15.96
325	6304	Blue	3.99	2.46	8468053	3.14	8468045	15.96
350	6305	White	4.58	2.75	8468054	4.99	8468044	18.5
400	6307	Purple	5.76	3.55	8468055	5.6	8468062	24.97
450	6308	Red	6.72	4.17	8468055	5.6	8468063	30.64
500	6309	Green	7.68	5.04	8468055	5.6	Without flow contro	52.00
550	6310	Yellow/ Green	8.60	6.27	8468055	5.6	Without flow contro	52.00

4) Configuration for BLFC

Part Number	8468057	8468056	8468052	8468053	8468054	8468055
Flow Rate L/m	0.83	1.13	1.47	3.14	4.99	5.6



5) Configuration for DLFC

Part Number	8468064	8468043	8468042	8468060	8468061	8468045	8468044	8468062	8468063	Without flow controller
Flow Rate L/m	3.33	4.31	7.15	7.64	10.82	15.96	18.5	24.97	30.64	52.00

Note: Above configuration and related curve for reference only.

3.4. Parameter settlement

①T1 Service timeT1

Service timeT1

Water treatment capacity:  $Q = V_R \times K \div Y_D \text{ (m}^3\text{)}$

- Hardness of Inlet Water, mmol/L.
- Exchange factor, (mmol/L), 400~1000.
- Down-flow regeneration, take 400~750.
- Up-flow regeneration, take 450~1000.
- If the inlet water hardness is higher, the factor is smaller.
- Resin volume (m<sup>3</sup>).

By hours:  $T1 = Q \div Q_h \text{ (Hour)}$

- Water treatment capacity per hour (m<sup>3</sup>/h)
- Water treatment capacity (m<sup>3</sup>)

By days:  $T1 = Q \div Q_d \text{ (Day)}$

- Water treatment capacity per day (m<sup>3</sup>/h)
- Water treatment capacity (m<sup>3</sup>)

②Backwash time T2

It is subject to the turbidity of inlet water. Generally, It is suggested to be set 10 ~ 15 minutes. The higher the turbidity is, the longer backwash time can be set. However, if the turbidity is more than 5FTU, it should be better to install a filter in front of the exchanger.

③Brine & slow rinse time T3

$$T3 = (40 \sim 50) \times H_R \text{ (min)}$$

$$\text{Generally, } T3 = 45H_R \text{ (min)}$$

In this formula,  $H_R$  — the height of resin in exchange tank (m)

④Brine refill timeT4

$$T4 = 0.34 \times V_R \div \text{Brine refill speed (min)}$$

In this formula,  $V_R$  — Resin volume (m<sup>3</sup>)

$$T5 = 12 \times H_R \text{ (min)}$$

Generally, the water for fast rinse is 3 ~ 6 times of resin volume. It is suggested to be set 10 ~ 16 minutes, but subject to the outlet water reaching the requirement.

Exchange factor

⑤Exchange factor=E/(k × 1000)

In this formula, E — Resin working exchange capability (mol/m<sup>3</sup>), it is related to the quality of resin. Down-flow regeneration, take 800 ~ 900. Up-flow regeneration, take 900 ~ 1200.

K—Security factor, always take 1.2 ~ 2. it is related to the hardness of inlet water: the higher the hardness is, the bigger the K is.

⑥Regeneration time: The whole cycle for generation is about two hours. Please try to set up the regeneration time when you don't need water according to the actual situation.

The calculation of parameters for each step is only for reference, the actual proper time will be determined after adjusting by water exchanger supplier. This calculation procedure of softener is only for industrial application; it is not suitable for small softener in residential application.

### 3.5. Parameter Enquiry and Setting

#### (1)Terminal User Parameter Enquiry

When light on, press and hold both and for 5 seconds to lift the button lock statuses; then press and light on, enter to program display mode; press or to view each value according to below process. (Press exit and turn back to service status)

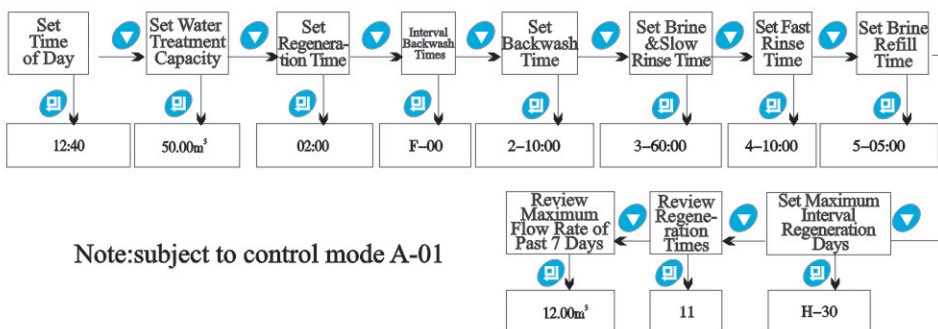

Note:subject to control mode A-01





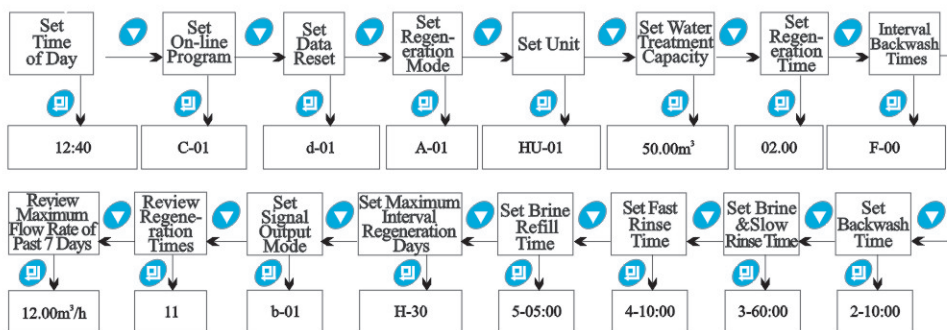

























#### (2)Technician or Factory Parameter Enquiry













































Power on, press , , and in sequence can enter into technician or factory parameter enquiry and setting status. Press or following below operation sequence can enquiry relevant parameter (Press to turn back).

















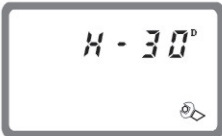



MODEL:73605 73605B 73605/41206L 73605B/41206L



(3)Parameter Setting and Enquiry Step One (Available for Technician, Factory and End User)  
 In program setting status, press ▲ or ▼ can change every parameters, following is the parameters setting example when control mode is A-03:





















Item	Steps	Symbol
Time of Day	When time of day “12:12” continuously flash, it reminds to reset; 1.Press  to enter into program display mode; both  and  symbol light on, “:” flash; Press  , both and hour value flash, through ▲ or ▼ to adjust the value; 2.Press  again, both and hour value flash, through ▲ or ▼ to adjust the minute value; 3.Press  and finish adjustment, press  to turn back.	
Water Treatment Capacity	1. In water treatment capacity enquiry program status display  and 50.00, then press  and enter into program set mode.  And 50.00 Flash. 2.Press ▲ or ▼ to adjust the water treatment capacity value (m <sup>3</sup> ) ; 3.Press  and finish adjustment, press  to turn back.	
Regeneration Time	1.In regeneration time enquiry program status, press  enter into program set mode. 2.Press  then  and 00 flash, Press ▲ or ▼ to adjust minute value. 3.Press  and finish adjustment, press  to turn back.	
Exchange Factor	1. In exchange factor enquiry program status, displays AL.55, press  enter into program set mode.  and 55 flash. 2.Press ▲ or ▼ to adjust the exchange factor. 3.Press  and finish adjustment, press  to turn back.	
Resin Volume	1. In resin volume enquiry program status, show as 20L, then press  enter into program set mode.  and 20 flash. 2.Press ▲ or ▼ to adjust the resin volume. 3.Press  and finish adjustment, press  to turn back.	

<p>Feed Water Hardness</p>	<p>1. In resin volume enquiry program status, show as yd1.2, then press  enter into program set mode.  and 1.2 flash.</p> <p>2.Press  or  to adjust the feed water hardness.</p> <p>3.Press  and finish adjustment, press  to turn back.</p>	
<p>Interval Backwash Times</p>	<p>1.In interval backwash times enquiry program status, show as F-00, then press  enter into program set mode.  and 00 flash.</p> <p>2.Press  or  to adjust the times.</p> <p>3.Press  and finish adjustment, press  to turn back.</p>	
<p>Backwash Time</p>	<p>1.In backwash time enquiry program status, show as and 2-10: 00, then press  enter into program set mode.  and 10:00 flash.</p> <p>2.Press  or  to adjust backwash time.</p> <p>3.Press  and finish adjustment, press  to turn back.</p>	
<p>Brine&amp; Slow Rinse Time</p>	<p>1. In brine&amp; slow rinse time enquiry program status, show as  and 3-60: 00, then press  enter into program set mode.  and 60:00 flash.</p> <p>2.Press  or  to adjust brine&amp; slow rinse time.</p> <p>3.Press  and finish adjustment, press  to turn back.</p>	
<p>Fast Rinse Time</p>	<p>1.In fast rinse time enquiry program status, show as  and 4-10: 00, then press  enter into program set mode.  and 10:00 flash.</p> <p>2.Press  or  to adjust fast rinse time.</p> <p>3.Press  and finish adjustment, press  to turn back.</p>	
<p>Brine Refill Time</p>	<p>1.In brine refill time enquiry program status, show as  and 5-05: 00, then press  enter into program set mode.  and 05:00 flash.</p> <p>2.Press  or  to adjust brine refill time.</p> <p>3.Press  and finish adjustment, press  to turn back.</p>	















<p>Maximum Interval Regeneration Days</p>	<p>1.In maximum interval regeneration days enquiry program status, show as H-30, then press  enter into program set mode.  and 30 flash. 2.Press  or  to adjust brine refill time. 3.Press  and finish adjustment, press  to turn back.</p>	
<p>Maximal flow rate of previous seven days</p>	<p>1.Press  in working status to enter into enquiry status,  flash. Press  or  to view the maximal flow rate of previous 7 days. 2.Press  back to working status after enquiry.</p>	
<p>Review Regeneration Times</p>	<p>1.In program display mode press  or  to select review regeneration times program, then press  and enter into program enquiry mode. 2. Press  to turn back.</p>	

(4)Parameter Setting and Enquiry Step Two (Available for Technician and Factory)











Power on, press ,  and  in sequence can enter into technician and factory setting status. Parameters set as below:

<p>On-line Program</p>	<p>1.In On-line program enquiry status, display C-01, press  enter into setting status,  and 01 flash. 2.Press  or  to select preference program. 3.Press  to finish on-line program select, press  to return.</p>	
<p>Set Clear Data</p>	<p>1.In On-line program enquiry status, display d-01, press  enter into setting status,  and 01 flash. 2.Press  or  to alter to d-02. 3.Press  to finish clear data change, press  to return.</p>	
<p>Control Mode</p>	<p>1.In control mode enquiry status,press  enter into setting status,  and 01 flash. 2.Press  or  select control mode among A-01/02/03/04/05/06. 3.Press  to finish control mode change, press  to return.</p>	

## MODEL:73605 73605B 73605/41206L 73605B/41206L

Unit of volume	<p>1. In unit of volume enquiry status, press  enter into setting status,  and 01 flash.</p> <p>2. Press  or  select among m3/L/gal.</p> <p>3. Press  to finish unit of volume change, press  to return.</p>	
Signal Output Mode	<p>1. In signal output mode enquiry status, display b-01, press  enter into setting status,  and 01 flash.</p> <p>2. Press  or  to alter to b-02.</p> <p>3. Press  to finish signal output mode change, press  to return.</p>	

For example, the fast rinse time of a softener is 12 minutes. After regenerating, the chloridion in the outlet water is always higher than normal, indicating that there is not enough time for fast rinse. If you want the time to set to 15 minutes, the modification steps as follows:

- ① Press  and  hold both and to lift the button lock statues (  light off ) ;
- ② Press  and enter into program display mode;
- ③ Press  or  to select set fast rinse program;
- ④ Press , fast rinse time value flashes;
- ⑤ Press  or  until 12 changed to 15;
- ⑥ Press , there is a sound “Di” and the figure stop flashing; the program back to enquiry status
- ⑦ If you want to adjust other parameters, you can repeat the steps from ② to ⑤; If you don’ t, press  and quit from the enquiry stat, the display will show the current service status.

### 3.6. Trial running

After installing the multi-functional flow control valve on the resin tank with the connected pipes, as well as setting up the relevant parameter, please conduct the trail running as follows:

- A. Open the bypass, after cleaning the foreign materials in the pipe, close the bypass.
- B. Fill the brine tank with the planned amount of water and adjust the air check valve. Then add solid salt to the tank and dissolve the salt as much as possible.
- C. Switch on power. Press  and go in the Backwash position; you can hear the sound of air-out from the drain pipeline. After all air is out of pipeline, clean the foreign materials in the resin tank until the outlet water is clean. It will take 8~10 minutes to finish the whole process.

MODEL:73605 73605B 73605/41206L 73605B/41206L

D.Press  , turning the position from Backwash to Brine& Slow Rinse; enter in the process of Brine& Slow Rinse. The air check valve close when control valve finished sucking brine, then slow rinse start to work. It is about 60~65minutes for whole process.

E.Press  , turning to Fast Rinse position. Valve start to fast rinse. After brine tank is being refilled with water to the required level. It takes about 10minutes, and then adds solid salt to the brine tank.

F.Press  , making the control valve turn to Brine refill position. After 5~6minutes, take our some outlet water for testing: if the water hardness reach the requirement, and the chloridion in the water is almost the same compared with the inlet water, then go to the next step.

G.Press  , making the control valve return to Service Status.

Note:

- When the control valve enters into the regeneration status, all program can be finished automatically according to the setting time; if you want one of steps terminated early, you can press  .
- If water inflow too fast, the media in tank will be damaged. When water inflow slowly, there is a sound of air emptying from drain pipeline.
- After changing resin, please empty air in the resin according to the above Step C.
- In the process of trial running, please check the water situation in all position, ensuring there is no resin leakage.
- The time for Backwash, Brine& Slow Rinse, Brine Refill and Fast Rinse position can be set and executed according to the calculation in the formula or suggestions from the control valve suppliers.

### 3.7. Trouble-Shooting

#### A. Control Valve Fault

Problem	Cause	Correction
1. Softener fails to regenerate.	A. Electrical service to unit has been interrupted. B. Regeneration cycles set incorrect. C. Controller is defective. D. Motor fails to work.	A. Assure permanent electrical service (Check fuse, plug, pull chain or switch). B. Reset regeneration cycles. C. Replace controller. D. Replace motor.
2. Regeneration time is not correct.	A. Time of Day not set correctly. B. Power failure more than 3 days.	Check program and reset time of day.
3. Softener supply hard water.	A. Bypass valve is open or leaking. B. No salt in brine tank. C. Injector plugged. D. Insufficient water flowing into brine tank. E. Leak at O-ring on riser pipe. F. Internal valve leak. G. Regeneration cycles not correct. H. Shortage of resin. I. Bad quality of feed water or turbine blocked.	A. Close or repair bypass valve. B. Add salt to brine tank and maintain salt level above water level. C. Change or clean injector. D. Check brine tank refill time. E. Make sure riser pipe is not cracked. Check o-ring and tube pilot. F. Change valve body. G. Set correct regeneration cycles in the program. H. Add resin to mineral tank and check whether resin leaks. I. Reduce the inlet turbidity, clean or replace turbine.
4. Softener fails to draw brine.	A. Line pressure is too low. B. Brine line is plugged. C. Brine line is leaking. D. Injector is plugged. E. Internal control leak. F. Drain line is plugged. G. Sizes of injector and DLFC not match with tank.	A. Increase line pressure. B. Clean brine line. C. Replace brine line. D. Clean or replace new parts. E. Replace valve body. F. Clean drain line flow control. G. Select correct injector size and DLFC according to the P23 requirements.
5. Unit used too much salt.	A. Improper salt setting. B. Excessive water in brine tank.	A. Check salt usage and salt setting. B. See problem no.6.



MODEL:73605 73605B 73605/41206L 73605B/41206L

Control Valve Fault

<p>6.Excessive water in brine tank.</p>	<p>A. Overlong refilling time. B. Too much water left after brine draw. C. Foreign material in brine line. D. Power outage when brining and system without liquid level controller. E. Brine refill out control. F. Brine motor defect.</p>	<p>A. Reset correct refilling time. B. Check injector and brine line make sure no jet. C. Clean brine valve and brine line. D. Stop water supplying and equip the liquid level controller. E. Repair or replace liquid level controller. F. Check the brine motor.</p>
<p>7. Pressure lost or iron in conditioned water.</p>	<p>A. Iron in the water supply pipe. B. Iron mass in the softener. C. Fouled resin bed. D. Too much iron in the raw water.</p>	<p>A. Clean the water supply pipe. B. Clean valve and add resin cleaning chemical, increase frequency of regeneration. C. Check backwash, brine draw and brine tank refill. Increase frequency of regeneration and backwash time. D. Iron removal equipment is required to install before softening.</p>
<p>8. Loss of mineral through drain line.</p>	<p>A. Air in water system. B. Bottom strainer broken. C. Improperly sized drain line control.</p>	<p>A. Assure that well system has proper air eliminator control. B. Replace new bottom strainer. C. Check for proper drain rate.</p>
<p>9. Control cycle continuously.</p>	<p>A. Locating signal wiring breakdown. B. Controller is faulty. C. Foreign material stuck the driving gear. D. Time of regeneration steps were set to zero.</p>	<p>A. Check and connect locating signal wiring. B. Replace controller. C. Take out foreign material. D. Check program setting and reset.</p>
<p>10. Drain flows continuously.</p>	<p>A. Internal valve leak. B. When electricity fails to supply, valve stops backwash or rapid rinse position.</p>	<p>A. Check and repair valve body or replace it. B. Adjust valve to service position or turn off bypass valve and restart when electricity supply.</p>
<p>11. Interrupted or irregular brine.</p>	<p>A. Water pressure too low or not stable. B. Injector is plugged or faulty. C. Air in resin tank. D. Floccules in resin tank during backwash.</p>	<p>A. Increase water pressure. B. Clean or replace injector. C. Check and find the reason. D. Clean the floccules in resin tank.</p>
<p>12. Water flow out from drain or brine pipe after regeneration.</p>	<p>A. Foreign material in valve which makes valve can't be closed completely. B. Hard water mixed in valve body. C. Water pressure is too high which result in valve doesn't get the right position. D. Under the Backwash position, pipelines between the outlet and brine line are communicated.</p>	<p>A. Clean foreign material in valve body. B. Change valve core or sealing ring. C. Reduce water pressure or use pressure release function. D. Install a check Valve, solenoid valve in front of the outlet or install a liquid level controller in the brine tank.</p>

**Control Valve Fault**

13. Salt water in softener water.	A. Foreign material in injector or injector fails to work. B. Brine valve cannot be shut-off. C. Time of rapid rinse too short.	A. Clean and repair injector. B. Repair brine valve and clean it. C. Extend rapid rinse time.
14. Unit capacity decreases.	A. Unit fails to regenerate or regenerate not properly. B. Fouled resin bed. C. Salt setting not proper. D. Softener setting not proper. E. Raw water quality deterioration. F. Turbine of flow meter is stuck.	A. Regenerate according to the correct operation requirement. B. Increase backwash flow rate and time, clean or change resin. C. Readjust brine drawing time. D. According to the test of outlet water, recount and reset. E. Regenerate unit by manual temporary then reset regeneration cycle. F. Disassemble flow meter and clean it or replace a new turbine.

**B. Controller Fault**

Problem	Cause	Correction
1. All indicators display on front panel.	A. Wiring of front panel with controller fails to work. B. Control board is faulty. C. Transformer damaged. D. Electrical service not stable.	A. Check and replace the wiring. B. Replace control board. C. Check and replace transformer. D. Check and adjust electrical service.
2. No display on front panel.	A. Wiring of front panel with controller fails to work. B. Front panel damaged. C. Control board damaged. D. Electricity is interrupted.	A. Check and replace wiring. B. Replace front panel. C. Replace control board. D. Check electricity.
3. E1 Flash	A. Wiring of locating board with controller fails to work. B. Locating board damaged. C. Mechanical driven failure. D. Faulty control board. E. Wiring of motor with controller is fault. F. Motor damaged.	A. Replace wiring. B. Replace locating board. C. Check and repair mechanical part. D. Replace control board. E. Replace wiring. F. Replace motor.
4. E2 Flash	A. Hall component on locating board damaged. B. Wiring of locating board with controller fails to work. C. Control board is faulty.	A. Replace locating board. B. Replace wiring. C. Replace control board.
5. E3 or E4 Flash	A. Control board is faulty.	A. Replace control board.

MODEL:73605 73605B 73605/41206L 73605B/41206L

6.Full screen display then display model, circularly display.	A.Motor stuck or short circuit. B.Ball valve stuck or short circuit. C.Three way ball valve stuck or short circuit.	A.Replace the motor. B.Replace the ball valve. C.Replace three way ball valve.
7.Interlock or one use one standby failure	A.Menu setting improper. B.Interlock wiring insert improper. C.Three way ball valve wiring insert wrong.	A.Reset B.Re-insert wiring C.Re-insert wiring

MODEL:73605 73605B 73605/41206L 73605B/41206L

**8.Assembly & Parts**  
**73605 Valve Structure**

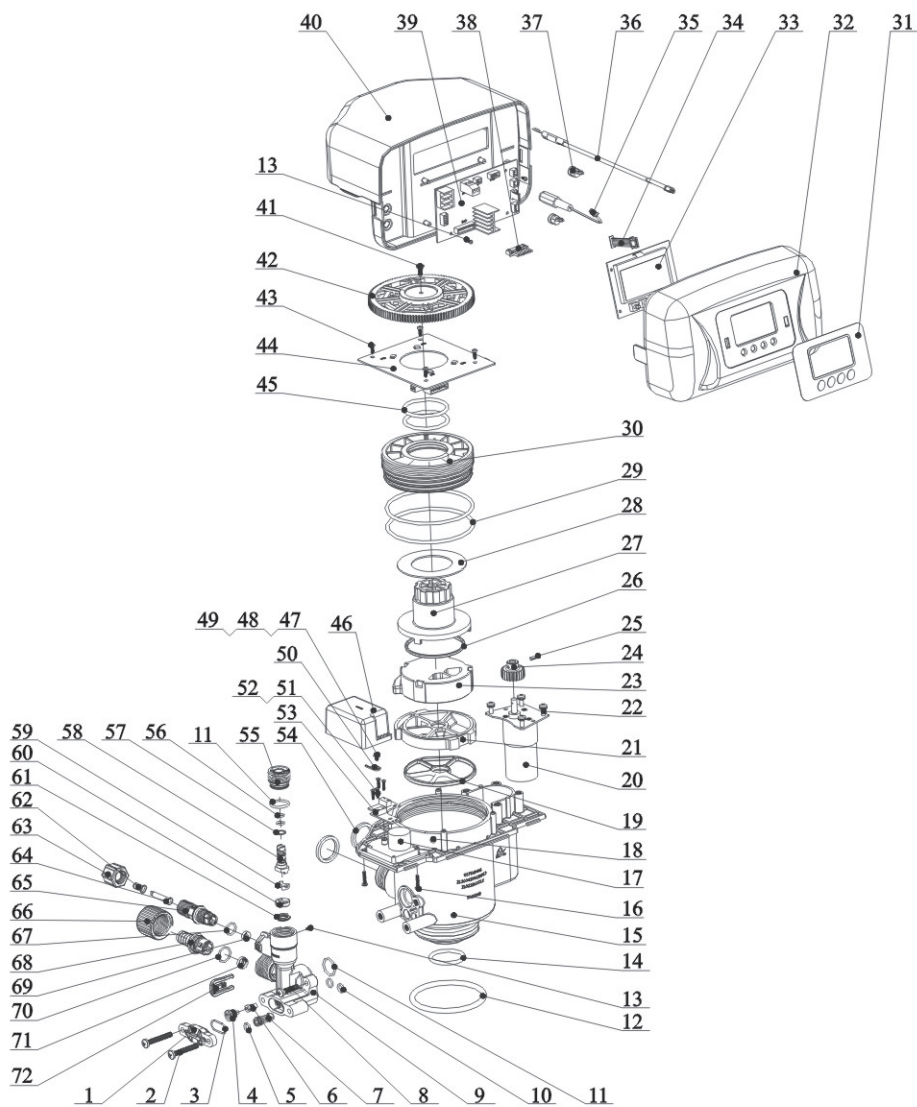

MODEL:73605 73605B 73605/41206L 73605B/41206L

73605 Spare parts and part number

Item Number	Description	Part number	Quantity
1	Cover, Injector	8315003	1
2	Screw, Cross	8902017	2
3	O-ring	8378148	1
4	Nozzle, Injector	8454009	1
5	O-ring	8378015	1
6	Throat,Injector	8467009	1
7	Filter Screen	5336008	1
8	Screw, Cross	8902015	1
9	Injector Body	8008008	1
10	O-ring	8378016	2
11	O-ring	8378182	2
12	O-ring	8378143	1
13	Screw, Cross	8909004	3
14	O-ring	8378116	1
15	Valve Body	5022047	1
16	Screw, Cross	8909010	2
17	Motor	6158052	1
18	Screw, Cross	8909009	4
19	Seal Ring	8370075	1
20	Motor	6158012	1
21	Fixed Disk	8469048	1
22	Screw, Cross	8902005	4
23	Moving Disk	8459050	1
24	Small Gear	8241019	1
25	Pin	8993003	1
26	Moving Seal Ring	8370065	1
27	Shaft	8258014	1
28	Anti-friction Washer	8216012	1
29	O-ring	8378180	2
30	Fitting Nut	8092033	1
31	Label	8865040	1
32	Front Cover	8300034	1
33	Display Board	6381003	1
34	Wire for power	5512001	1
35	Wire for Display Board	5513001	1
36	Probe Wire	6386001	1

MODEL:73605 73605B 73605/41206L 73605B/41206L

37	Cable Clip	8126004	2
38	Wiring of Locating Board	5511014	1
39	Control Board	6382024	1
40	Dust Cover	8005040	1
41	Screw, Cross	8909013	1
42	Gear	5241011	1
43	Screw, Cross	8909008	4
44	Locating Board	6378007	1
45	O-ring	8378123	2
46	Dust Cover	8005034	1
47	Screw, Cross	8902034	1
48	Washer	8952008	1
49	Spring Washer	8953008	1
50	Pick	8152017	1
51	Screw, Cross	8902035	4
52	Spring Washer	8953007	4
53	Control Board	6382025	1
54	Sealing Gasket	8371001	2
55	Fitting Nut	8092034	1
56	O-ring	8378155	2
57	Anti-friction Washer	8216013	1
58	Shaft	5258006	1
59	Moving Disk	8459034	1
60	Fixed Disk	8469050	1
61	Seal Ring	8370054	1
62	Tube	8457039	1
63	Hexagonal Nut	8940001	1
64	Filter Screen	8336008	1
65	Connector	8458068	1
66	Articulated Nut	8945025	1
67	O-ring	8378169	1
68	Connector	8458064	1
69	Brine Line Flow Control	8468055	1
70	O-ring	8378179	1
71	Drain Line Flow Control	8468063	1
72	Clip	8270010	1

MODEL:73605 73605B 73605/41206L 73605B/41206L

41206L Bypass structure and part number

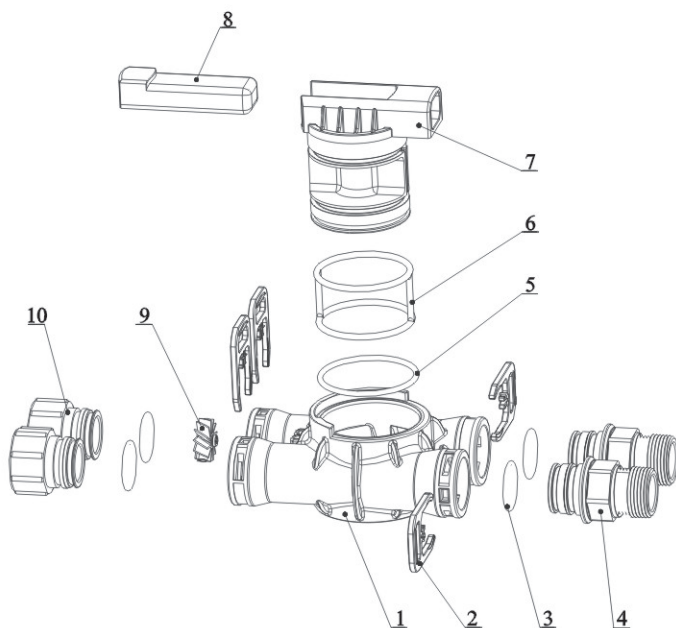

41206L Bypass structure and part number

Item number	Description	Part number	Quantity
1	Valve Body	8022154	1
2	Clip	8270004	4
3	O-ring	8378081	4
4	NPT Connector	8458065	2
5	O-ring	8378110	1
6	Seal Ring	8370007	1
7	Spool	8259003	1
8	Handle	8253051	1
9	Impeller	5295003	1
10	Animated Connector	8945001	2

## 4. Warranty Card

Dear client:

This warranty card is the guarantee proof of RUNXIN brand multi-functional flow control valve. It is kept by client self. You could get the after-sales services from the supplier which is appointed by RUNXIN manufacturer. Please keep it properly. It couldn't be retrieved if lost. It couldn't be repaired free of charge under the below conditions:

1. Guarantee period expired.(One year);
2. Damage resulting from using, maintenance, and keeping that are not in accordance with the instruction;
3. Damage resulting from repairing not by the appointed maintenance personnel;
4. Content in guarantee proof is unconfirmed with the label on the real good or be altered;
5. Damage resulting from force majeure.

Product Name		Multi-functional Flow Control Valve for Water Treatment Systems		
Model		Code of Valve Body		
Purchase Company Name		Tel/Cel.		
Problem				
Solution				
Date of Repairing		Date of Accomplishment		Maintenance Man Signature

When product need warranty service, please fill in the below content and sent this card together with the product to the appointed suppliers or Runxin company.

End-user Company Name		Tel/Cel.		
Purchase Company Name		Tel/Cel.		
Model		Code of Valve Body		
Tank Size $\phi$ ×		Resin Tank Size L	Raw Water Hardness	mmol/L
Water Source: Ground-water <input type="checkbox"/> Tap Water <input type="checkbox"/>		Water Treatment Capacity	Backwash Time	min
Brine & Slow Rinse Time min		Brine Refill Time min	Fast Rinse Time	min
Problem Description				





---

**WENZHOU RUNXIN MANUFACTURING MACHINE CO.,LTD**

ADD: Jinger Road, Shatou Group, Linjiang, Lucheng District, Wenzhou, Zhejiang, China

Tel: +86-577-88635628 88630038 Fax: +86-0577-88633258

Http://www.run-xin.com Email:sales@run-xin.com