

# Residential Softener

RL-R50N

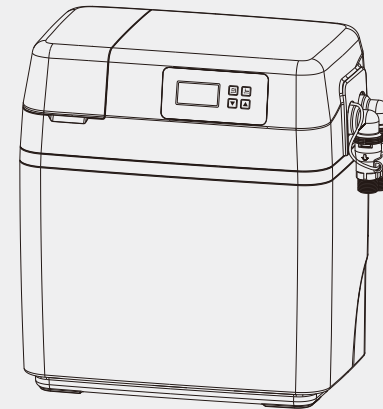

## User Manual

Please read this manual in details before using the device and keep it properly in order to consult in the future.

0WRX.466.712

Rev.A1912

## Catalogue

Preface.....	2
1. Product Profile.....	2
2. Working Principle.....	2
3. Assembly & Parts.....	3
4. Function and Characteristics.....	3
5. Application.....	5
6. Technical Parameters.....	5
7. Setting and Usage.....	6
7.1 Control Valve Setting and Usage.....	6
※The Function of Control Panel and Parameter Setting.....	6
※User Parameter Setting and Inquiry.....	7
※User Mode.....	11
7.2.Usage of Brine Valve.....	13
8. Usage Illustration.....	13
9. Notice.....	15

※Note: The design and specifications are subject to the changes without prior notice. We reserve the right of interpretation to the user manual.

## Preface

Thanks for choosing our softener series products. These products are featured by good softening effects, stable performance, excellent appearance, compact structure and simple handling, etc. They can meet the soft water demand of family washing, bathing, cleaning, water heater, etc. Besides, they also can be applied to supplying high quality soft water for institutions, schools, group companies, and so on.

## 1. Product Profile

The product is working automatically and intelligently. It adopts food-grade cation resin to soften water with characteristics of big flow rate and good softening effect, efficiently reducing calcium and magnesium ion content of tap water. After the resin is saturated, the regeneration function will automatically control the product to brine and conduct regeneration, recovering the softening function of the resin. It can automatically realize the function of backwash, brine & slow rinse, fast rinse and brine refill without manual operations.

## 2. Working Principle

Ion exchange technique is applied to the softener. It can realize the purpose of wiping off the lime scale (Calcium carbonate and magnesium carbonate) through replacing the calcium ion and magnesium ion by the sodium ion of the resin. According to the pre-set program, it can automatically control the open and close of each valve, so as to conducting softening, backwash, brine & slow rinse, fast rinse and brine refill.

## 3. Assembly & Parts

### Integrated type structure

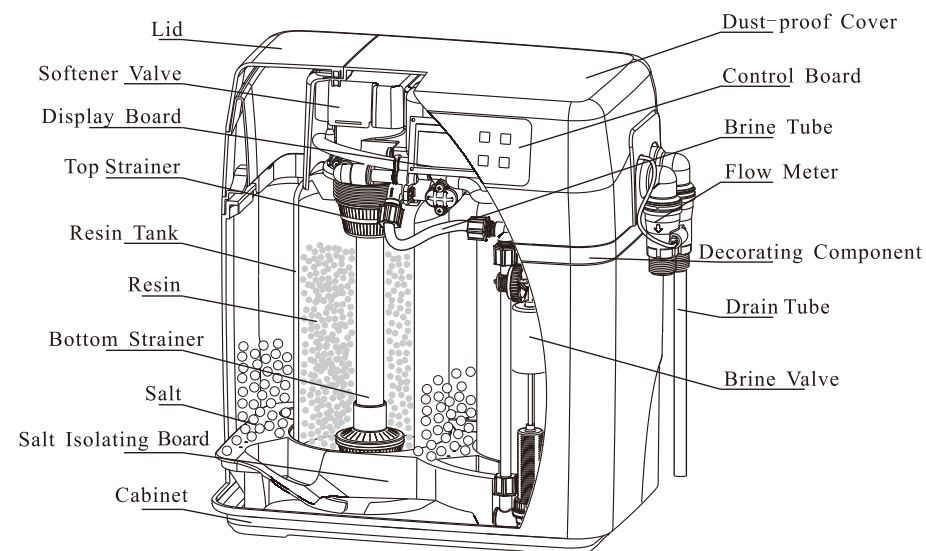

## 4. Function and Characteristics

### 1. Regeneration starts automatically:

According to the set hardness of raw water and regeneration time by user, the system will start the regeneration program automatically.

### 2. Water capacity can be calculated automatically:





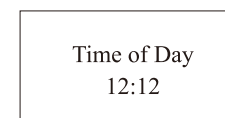

After inputting the hardness value, the control valve will automatically calculate the system water treatment capacity and display on the LCD screen.

### 3. Automatic memory function:



The parameters set by users, such as regeneration time, backwash time, brine & slow rinse time, fast rinse time, brine refill time and so on, can be saved permanently no matter how long the power is off. If power off is more than 3 days, it will always display this interface to remind to reset the time of day. (See below picture.)



#### 4. Language:

Chinese, English or Spanish can be chosen. After power connected within 6 seconds, press and hold both  and  for 2 seconds to enter into “Set Language” interface. Press  to confirm and press  or  to choose the language. After that, press  to save and  to exit.

#### 5. Buttons lock function:

No operations to buttons within 1 minute, buttons are locked. Press and hold the  and  buttons for 5 seconds to unlock. This function can avoid incorrect operation.

#### 6. Duplex system supply water in parallel but regeneration separately:

Two tanks in parallel, valve controls the regeneration separately and supplies the water in parallel and continuously.

#### 7. Regeneration mode can be meter delayed or intelligent meter immediate:

Meter delayed: Regenerates on the day although the available volume of treated water drops to zero (0). Regeneration starts at the regeneration time. It can avoid the shortage of water when regeneration.

Intelligent meter immediate: Regenerates immediately when the available volume of treated water drops to zero (0).

#### 8. Working automatically:

Softening: Under a certain pressure and flow rate, the raw water flows through the product, at the same time, the calcium ion and magnesium ion of raw water are replaced by the sodium ion of resin, reducing the content of calcium ion and magnesium ion and realizing the purpose of softening water.

Backwash: After the resin is saturated and lose softening efficacy, the program starts backwash before regeneration. On the one hand, it can wipe off the broken resin and the impurity on surface layer of resin. On the other hand, the reversed flow direction can loosen the tight resin and make it benefit for the touch between resin particle and regeneration liquid.

Brine & slow rinse: A certain concentration of brine flows through the resin. Meanwhile, the calcium ion and magnesium ion on the resin surface layer are replaced by the sodium ion, making the invalid resin regeneration and recovering its softening capacity.

Fast rinse: Discharge the residual brine and compact the resin particle so as to reach the best softening effect. By this step, the product automatically finished one service cycle.

Brine refill: The brine tank is refilled with water to dissolve the salt so as to provide the saturated brine for next regeneration.

#### 9. Salt shortage alarm

The system will automatically calculate the salt consumption after inputting the resin volume and one time salt adding quantity. When the residual salt is not enough for one regeneration, the display in service status will show “Check Remaining Salt”. When the salt volume is set to 0, this alarm function will be closed.

#### 10. Resin maintenance or Call for Check-up

The system will automatically calculate the regeneration times. When the resin is almost invalid, the display in service status will show “Maintenance Call for Check-up”.

## 5. Application

The product can be used for treating the tap water or other qualified raw water.

## 6. Technical Parameters

Product Parameters:

Model	Rated Flow Rate (L/h)	Suggested Flow Rate (L/h)	Water Capacity Per Cycle (L)	Rated Treated Water Quantity (m <sup>3</sup> )	FRP Tank Dimension (Φ×h) mm	Cation Resin Volume (L)	Brine Tank Size (in)	Drain
RL-R50	500	500~2000	1200	320	155×331	7	0613×2	Ø12

Remark: Match with F126 valve, the maximum flow rate will be 2000L/h when two tanks supply water in parallel.

※ Water treatment capacity per cycle is various according to the difference water quality of different region.

The standard testing conditions is:

Water temperature: 25℃,

Raw water hardness: 150mg/L(CaCO<sub>3</sub>).

※ The outlet water conforms with the regulations (2001) of Safety and Function Assessment for Drinking Water Treatment Device— General Treatment Device.

※ Transformer— Input: AC100~240V / 50Hz~60Hz; Output: DC12V / 1.5A

Service Conditions:

Water Pressure: 0.15-0.4MPa;



Electrical Facility: AC100~240V / 50Hz~60Hz;

Water Temperature: 5~38°C

Environment Temperature: 4~40°C

Relative Humidity: 90% (25°C)

## 7. Setting and Usage

### 7.1. Control Valve Setting and Usage

#### ※The Function of Control Panel and Parameter Setting

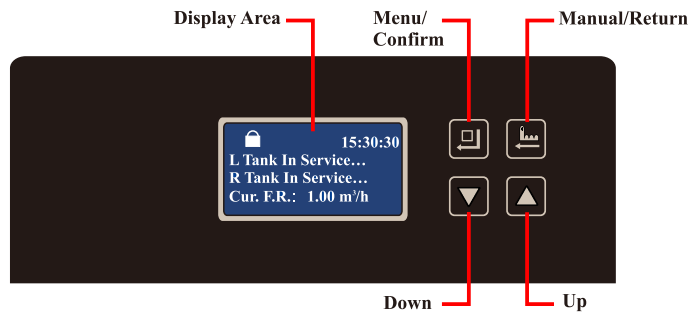

#### A. Button lock indicator

● Lights on, indicates the buttons are locked. At this moment, it is useless to press any single button (Under any status, no operation in one minute, will light on and lock the buttons.)

Solution: Press and hold both and for 5 seconds, the lights off.

#### B. Menu/Confirm button

● In service status, press to enter program setting status. Select the setting item can view the value.

● Press under setting enquiry status, data flickers, enter setting status and modify parameter value.

● Press after all program are set, and then the voice “Di” means all setting are success and return program display mode.

#### C. Manual/Return button

● Press in service status, it can proceed to next step. (Example: When the hardness of treated water is unqualified, press at unlock status to finish service, enter to regeneration instantly. When at regeneration status, press can enter to next step.)

● Press in enquiry status, and it will return to menu status; Press in program set status, and it will return to menu status.

● Press while adjusting the value, then it will return program display mode directly without saving value.

#### D. Down and Up

● In menu status, press or to view all values.

● In setting status, press or to adjust the parameter.





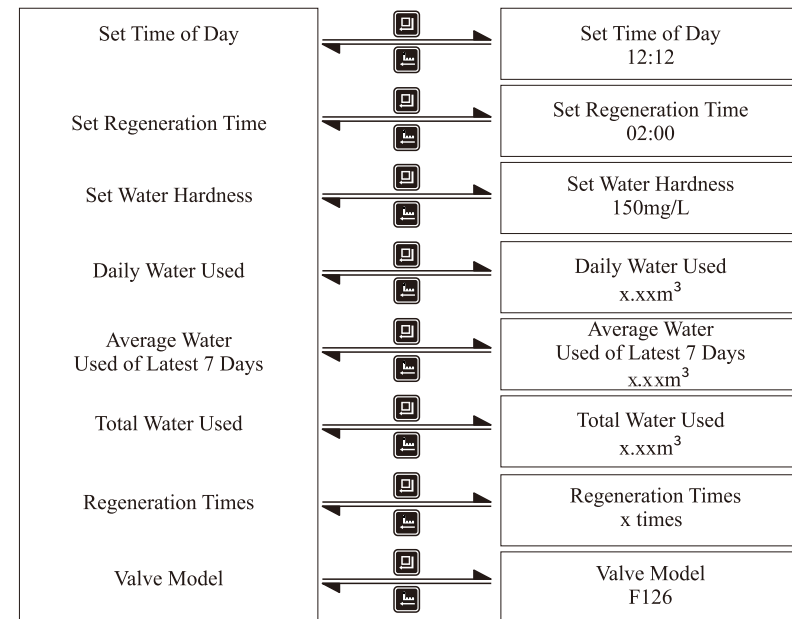







● Press and hold both and for 5 seconds to lift the Button Lock status.



















#### ※User Parameter Setting and Inquiry















Set or Inquiry		Parameter Set Range	Factory Default
Set	Time of Day	00:00 ~ 23:59	Current time
	Regeneration Time	00:00 ~ 23:59	02:00
	Water Hardness	50~999mg/L	150mg/L
Inquiry	Daily Water Used	/	x.xxm <sup>3</sup>
	Average Water Used of Latest 7 Days	/	x.xxm <sup>3</sup>
	Total Water Used	/	x.xxm <sup>3</sup>
	Regeneration Times	/	x times
Valve Model		F126	F126

After unlocking the system, if R and L tank both in service status, the parameters can be clear by pressing the  for 6 seconds, including the current day water used, average last 7 days water used, total water capacity used and regeneration times.

Items	Process steps	Symbol
Time of Day	<p>When  lights on, press and hold  and  for 5 seconds until the  lights off.</p> <p>1.Press  and enter into the status as figure LR1 shows. The item of “Set Time of Day” will be selected by system automatically.</p> <p>2. Then press , and the setting interface will display as the figure LR2; the hour value “12” flashes, through  or  to adjust the hour value.</p> <p>3. Then press  again, the minute value “30” flashes, through  or  to adjust the minute value.</p> <p>4. Lastly, press  and hear a sound “Di”, then finish adjustment.</p>	<div style="border: 1px solid black; padding: 5px; margin-bottom: 5px;">           » Set Time of Day            Set Regen. Time            Set Water Hardness            Daily Water Used            Average Water Used            Total Water Used            Regeneration Times            Valve Model         </div> <p style="text-align: center;">LR1</p> <div style="border: 1px solid black; padding: 5px; margin-bottom: 5px;">           Set Time of Day            12 : 30         </div> <p style="text-align: center;">LR2</p>

Regeneration Time	<p>1.Press  and enter into the status as figure LR1 shows.</p> <p>2. Press  and select the item of “Set Regen. Time”; then press , the setting interface will display as the figure LR3; hour value “02” flashes, through  or  to adjust the hour value.</p> <p>3. Then press , the minute value “00” flashes, through  or  to adjust the minute value.</p> <p>4. Lastly, press  and hear a sound “Di”, then finish adjustment.</p>	<div style="border: 1px solid black; padding: 5px; margin-bottom: 5px;">           Set Time of Day            » Set Regen. Time            Set Water Hardness            Daily Water Used            Average Water Used            Total Water Used            Regeneration Times            Valve Model         </div> <p style="text-align: center;">LR1</p> <div style="border: 1px solid black; padding: 5px; margin-bottom: 5px;">           Set Regen. Time            02 : 00         </div> <p style="text-align: center;">LR3</p>
Water Hardness	<p>1.Press  and enter into the status as figure LR1 shows.</p> <p>2.Press  twice and select the item of “Set Water Hardness”; then press , the setting interface will display as the figure LR4; hardness value “150” flashes, through  or  to adjust the hardness value.</p> <p>3. Lastly, press  and hear a sound “Di”, then finish adjustment.</p>	<div style="border: 1px solid black; padding: 5px; margin-bottom: 5px;">           Set Time of Day            Set Regen. Time            » Set Water Hardness            Daily Water Used            Average Water Used            Total Water Used            Regeneration Times            Valve Model         </div> <p style="text-align: center;">LR1</p> <div style="border: 1px solid black; padding: 5px; margin-bottom: 5px;">           Set Water Hardness            150mg/L         </div> <p style="text-align: center;">LR4</p>
Daily Water Used	<p>1.Press  and enter into the status as figure LR1 shows.</p> <p>2.Press  3 times and select the item of “Daily Water Used”; then press , the setting interface will display as the figure LR5.</p>	<div style="border: 1px solid black; padding: 5px; margin-bottom: 5px;">           Set Time of Day            Set Regen. Time            Set Water Hardness            » Daily Water Used            Average Water Used            Total Water Used            Regeneration Times            Valve Model         </div> <p style="text-align: center;">LR1</p> <div style="border: 1px solid black; padding: 5px; margin-bottom: 5px;">           Inquiry Daily Water Used            x.xx m<sup>3</sup> </div> <p style="text-align: center;">LR5</p>

<p>Inquiry Average Water Used of Latest 7 Days</p>	<p>1.Press  and enter into the status as figure LR1 shows. 2.Press  4 times and select the item of “Average Water Used of Latest 7 Days”; then press , the setting interface will display as the figure LR6.</p>	<p>Set Time of Day Set Regen. Time Set Water Hardness Daily Water Used » Average Water Used Total Water Used Regeneration Times Valve Model</p> <p>LR1</p> <p>Average Water Used x.xx m<sup>3</sup></p> <p>LR6</p>
<p>Total Water Used</p>	<p>1.Press  and enter into the status as figure LR1 shows. 2. Press  5 times and select the item of “Total Water Used”; then press , the setting interface will display as the figure LR7.</p>	<p>Set Time of Day Set Regen. Time Set Water Hardness Daily Water Used Average Water Used » Total Water Used Regeneration Times Valve Model</p> <p>LR1</p> <p>Total Water Used x.xx m<sup>3</sup></p> <p>LR7</p>
<p>Regeneration Times</p>	<p>1.Press  and enter into the status as figure LR1 shows. 2.Press  6 times and select the item of “Regeneration Times”; then press , the setting interface will display as the figure LR8.</p>	<p>Set Time of Day Set Regen. Time Set Water Hardness Daily Water Used Average Water Used Total Water Used » Regeneration Times Valve Model</p> <p>LR1</p> <p>Regeneration Times x times</p> <p>LR8</p>

<p>Valve Model</p>	<p>1.Press  and enter into the status as figure LR1 shows. 2. Press  7 times and select the item of “Valve Model”; then press , the setting interface will display as the figure LR9.</p>	<p>Set Time of Day Set Regen. Time Set Water Hardness Daily Water Used Average Water Used Total Water Used Regeneration Times » Valve Model</p> <p>LR1</p> <p>Valve Model F126</p> <p>LR9</p>
--------------------	--	---

**Illustration: After setting the water hardness, the display screen will show the total water treatment capacity or remaining water. If you think the water treatment capacity is too low to meet your demand, you can adjust the capacity by setting the water hardness. Under the condition of not affecting the outlet water quality, lowering the water hardness value can increase the water treatment capacity.**

**※User Mode**

After power on, it will show below figure 3 seconds and then enter into user mode.

```

*****
      F126
    ( 82602 )
*****

```

Process display example: The meter type softener valve

<p>15:30:30 L Tank In Service... R Tank In Service... Cur. F.R.: 1.00 m<sup>3</sup>/h</p>	<p>15:30:30 L Remain: 1.00 m<sup>3</sup> R Remain: 1.00 m<sup>3</sup> Regen.Time: 02:00</p>	<p>02:00:00 R Tank In Service... Cur. F.R.: 1.00 m<sup>3</sup>/h L In Backwash: 02:00</p>	<p>02:02:30 R Remain: 0.50 m<sup>3</sup> Cur. F.R.: 1.00 m<sup>3</sup>/h L In Backwash: 02:00</p>
---	---	---	---

The display when L and R in service

The display when R in service and L in backwash

02:03:30 R Tank In Service... Cur. F.R: 1.00 m³/h L In B.S.R.(DF): 35:00	02:03:30 R Remain: 0.50 m³ Cur. F.R: 1.00 m³/h L In B.S.R.(DF): 35:00	02:37:30 R Tank In Service... Cur. F.R: 1.00 m³/h L In Fast Rinse: 03:00	02:38:30 R Remain: 0.50 m³ Cur. F.R: 1.00 m³/h L In Fast Rinse: 03:00
---	--	---	--

The display when R in service and L in brine & slow rinse (Down-flow)

The display when R in service and L in fast rinse

02:40:30 R Tank In Service... Cur. F.R: 1.00 m³/h Brine Refilling: 01:30	02:40:30 R Remain: 0.50 m³ Cur. F.R: 1.00 m³/h Brine Refilling: 01:30	02:42:30 R Tank In Service... L Tank In Service... Cur. F.R: 1.00 m³/h	02:45:00 R Remain: 0.50 m³ L Remain: 1.00 m³ Regen. Time: 02:00
---	--	---	--

The display when R in service and brine tank is brine refilling

The display when L and R in service

02:00:30 L Tank In Service... Cur. F.R: 1.00 m³/h R In Backwash: 02:00	02:02:50 L Remain: 0.50 m³ Cur. F.R: 1.00 m³/h R In Backwash: 02:00
---	--

The display when L in service and R in backwash

The display is same as when L in service and R in regeneration as R in service and L in regeneration which will not be listed here.

L-Valve Motor  
Running...  
-00-

Display when L-valve motor running

M-Valve Motor  
Running...  
-00-

Display when M-valve motor running

R-Valve Motor  
Running...  
-00-

Display when R-valve motor running

Check Remaining Salt  
press ▼ 3s to clear

Check if there is still salt in brine tank

Maintenance  
Call for Check-up  
press ▲ 3s to clear

Maintenance or replace resin interface

12: 12

Check and verify the time of day

L-Valve Error **E1**	L-Valve Error **E2**	M-Valve Error **E1**	M-Valve Error **E2**
-------------------------	-------------------------	-------------------------	-------------------------

R-Valve Error **E1*	R-Valve Error **E2*	System Error! **E3**	System Error! **E4**
------------------------	------------------------	-------------------------	-------------------------

Display when system has error

The working process:  
Service→Backwash→ Brine & Slow Rinse→Fast Rinse→Brine Refill→ Service (Cycle repeats).

## 7.2. Usage of Brine Valve

①Under the brine & slow rinse status, with the floating ball, the brine valve can prevent the air from being inhaled which may affected the regeneration and usability. That is, the brine valve has the function of air check.

②Under the brine refill status, the brine valve can control the volume of refilling water by controlling the position of floater and control salt consumption.

## 8. Usage Illustration

After installing the device and setting the relevant parameters, please conduct the trial running as follows:

※Fill the brine tank with 2L water and start the device. (This step is necessary only for the situation that the device is put into use for the first time. The softener will refill the water automatically when works normally.)

※Switch on power. Press  and go in the Backwash status. Slowly open the inlet valve to 1/4 position (Avoiding opening the valve too quickly to damage the device and make the resin run off). At this moment, you can hear the sound of air-out from the drain pipeline. After all air is out of pipeline, then open inlet valve completely and conducting 2 minutes backwash, cleaning the foreign materials in the resin tank until the outlet water is clean.

02:00:00  
R Tank In Service...  
Cur. F.R:1.00 m³/h  
L In Backwash: 02:00

02:00:30  
R Remain:0.50 m³  
Cur. F.R:1.00 m³/h  
L In Backwash: 02:00

Backwash Status

※Press  and turn the status from Backwash to Brine & Slow Rinse. Under this status, the brine will be absorbed from the brine tank into the resin and the resin is regenerated. After absorbing, the brine valve will close. The system will still conduct about 25 minutes' slow rinse, wiping off the residual brine. The whole process will take about 35 minutes to finish.

02:03:30  
R Tank In Service...  
Cur. F.R:1.00 m³/h  
L In B.S.R.(DF): 35:00

02:03:30  
R Remain:0.50 m³  
Cur. F.R:1.00 m³/h  
L In B.S.R.(DF): 35:00

Brine & Slow Rinse Status

※Press  and turn into Fast Rinse status, starting to Fast Rinse. About 3 minutes fast rinse will discharge the residual brine and compact the resin particle so as to reach the best softening effect.

02:37:30 R Tank In Service... Cur. F.R.:1.00 m³/h L In Fast Rinse: 03:00	02:38:30 R Remain: 0.50 m³ Cur. F.R.:1.00 m³/h L In Fast Rinse: 03:00
---	--

Fast Rinse Status

※Press  and turn into Brine Refill status. The brine tank will be refilled with water to dissolve the salt. When the brine reaches the required height, the refilling will be stopped. The brine refilled is about 1.5L. The new saturated brine will be used for next regeneration.

02:40:30 R Tank In Service... Cur. F.R.:1.00 m³/h Brine Refilling: 01:30	02:40:30 R Remain:0.50 m³ Cur. F.R.:1.00 m³/h Brine Refilling: 01:30
---	---

Brine Refill Status

※When the sample outlet water is qualified, press  and finish the Fast Rinse. Then the device turns into Service status and start running.

15:30:30 R Tank In Service... L Tank In Service... Cur. F.R.: 1.00 m³/h	15:30:30 R Remain: 0.50m³ L Remain: 1.00m³ Regen. Time: 02:00
--	--

Service Status

**Illustration:** Under regeneration cycle, the softened water will stop flowing out from the outlet and each status will be completed automatically according to the setting time. If you want to finish one step in advance, you can press .

※During the trial running status, check each port. There should no mineral media flow out. Check each connection, ensure there is no leakage.

※The time of backwash, brine & slow rinse, fast rinse, brine refill, etc. could be suggested by dealer or professional personnel.

**Notice: Under normal situation, user does not need to do any operation except adding a certain amount of salt into the brine tank.**

## 9. Notice

Before reading and understanding the user manual, please do not operate the device.

※To ensure normal operation of the product after installed, please consult with professional installation or repairing personnel before use it.

※Forbid installing the device near heat source or take anti-heat protective measures when install near the heat source. It is also forbidden to connect the device with the hot-water pipeline or the pipeline with the possibility of hot-water returning. Forbid the product under the temperature lower than 1°C. Protect resin from freezing which may result in resin broken and disabled.

※Do not install the device near the place with acid or alkali substance or air, in case of the corrosion to the device.

※If the device is connected before hot water boiler or water heater, a check valve is needed, in case the hot water flowing back and damage the device.

※To ensure the safety, a separate drainage for the device is needed. The drainage connector should be prevented water flowing back. Stuck drainage or siphon should be avoided in case the drain water flows back from the drain pipeline or brine tank to the device.

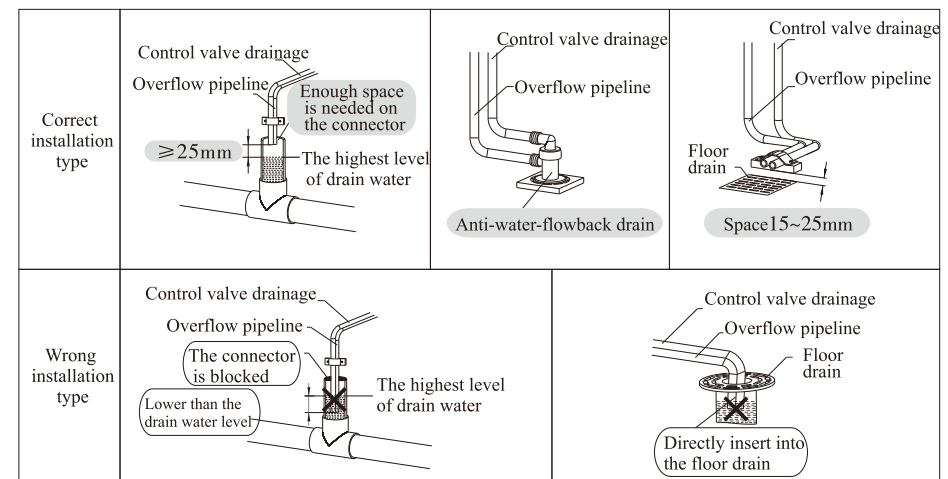



※Each inlet and outlet pipeline should be qualified with provincial sanitation department check and every installation should conform to the local installation regulations.

※It is suggested to use soft tube to connect with inlet, outlet, drainage and overflow connector. (Notice: the material of the connecting pipes and valves should use 304 stainless steel, alloy steel or high strength engineering plastic. Iron material is forbidden.)

※Use reagent to test raw water hardness, as the raw water hardness is closely related to the effect of softener and water treatment capacity. Use this softener under the condition that raw water hardness < 450mg/L.

※If the raw water fails to meet the standards of local tap water, such as the sediment concentration or residual chlorine content exceed the standard, etc., the pretreatment device should be installed before the device. (Such as Y type filter, ultra filter, and so on.)

※During the operation, please check the brine tank regularly to ensure there is brine in the tank. And when adding brine, please make sure that salt level is higher than water level (see picture I). When the salt level is lower 1/3 of water level (see picture II), please add in time. (Attention: Make sure the dissolving salt time is more than 6 hours so as to make the brine saturate.)

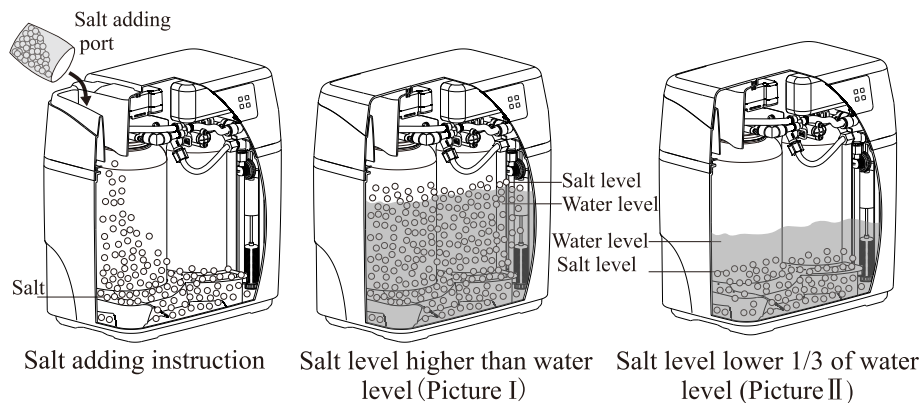

※Please strictly use the salt of more than 99% purity only. Any salt with additive or large particles is forbidden to add.

※Please use this product under the water temperature between 5~45°C, water pressure 0.15~0.6 MPa. Failure to use this product under such conditions voids the warranty.

※Sodium used in the water softening process should be considered as part of your overall dietary salt intake. Contact doctor if you are on a low sodium diet.

※Without being used for a long time or the pressure of the inlet water is instable, please close the inlet port and turn off the power. Before using again, please firstly conduct a regeneration cycle through manual operation so as to ensure the quality of softened water.

※During the service of product, prevent water hammer happened. Do not make these operations, such as quickly and fully opening valve, or quickly and fully closing valve or shut off water pump, etc.

※If the water demand is increasing (Compared to usual demand) or the hardness of raw water is rising, please reduce the regeneration cycle and increase the regeneration times, ensuring the softened water yield.

※When use the softener for the first time or the device is idle for long period, it is normal that the outlet water is yellow. Please put into use after 2~3 minutes' rinsing.

※Sometimes the brine in the brine tank will form salt bridge. That is, there is a space under the brine which prevents the salt from being dissolved and hinders the resin regeneration. It is suggested to check regularly. If there is salt bridge, please mash it.

※There will be on tank supplying water when the other tank is in regeneration, so the inlet is required to supply water normally.

※If the display board displays 12:12 and flashing, it means power off (more than 3 days) to remind to reset the time of day. If power off within a short time, the system has memory function, do not need to reset the time.

※Check the softener regularly, checking item:

a) If there is any pipeline leakage. If it does, contact with your seller.

b) If the overflow connector is blocked, if it does, clean it.

c) If the brine well is vertical. If it doesn't, put it in vertical.

(See picture on the right.)

※As the product is constantly updating, the possibility that the manual instruction can't accord with the product may happen.

So, it is subjected to the actual product.

**Special notice: The water pressure of tap water is changeable (Normally the pressure in night time is higher than day time), so pay attention to each connection to check if there is any leakage at the first two days after products installed.**

