



China Invention Patent No.:
ZL201410746627.1

Multi-functional Flow Control Valve for Water Treatment Systems

63518 (Old Model No.: N77A1)
63618 (Old Model No.: N77A3)
53518 (Old Model No.: N77B1)

User Manual

WENZHOU RUNXIN MANUFACTURING MACHINE CO.,LTD

ADD: NO.169, RUNXIN ROAD, SHANFU TOWN, WENZHOU, ZHEJIANG, CHINA.
TEL.:0086-577-88630038, 88576512, 85956057 FAX:0086-577-88633258
E-MAIL: sales@run-xin.com <http://www.run-xin.com>

Rev.A.2403



Please read this manual in details
before using the valve and keep it properly
in order to consult in the future

0WRX.466.511

MODEL: 63518-N77A1/63618-N77A3/53518-N77B1

Before the valve put into use, please fill in the below content so as to help us to refer in the future.

Softener System Configuration

Tank Size: Dia. _____ mm; Height _____ mm;

Resin Volume _____ L; Brine Tank Capacity _____ L;

Hardness of Raw Water _____ mmol/L;

Pressure of Inlet Water _____ MPa;

Control Valve Model _____; Number _____;

The Specification of Drain Line Flow Control _____;

Injector No. _____.

Water Source: Ground-water Filtered Ground-water Tap Water Other _____.

Parameter Set

Parameter	Unit	Factory Default	Actual Value
Control Mode A-01 (02, 03, 04)	/	A-01	
Water Treatment Capacity (Meter type)	m ³	80.00	
Service Days (Time clock type, by day)	D.	03	
Service Hours (Time clock type, by hour)	H.	20	
Regeneration Time	/	02:00	
Backwash Time	min.	10:00	
Brine & Slow Rinse Time	min.	60:00	
Brine Refill Time	min.	05:00	
Fast Rinse Time	min.	10:00	
Maximum Interval Regeneration Days	D.	30	
Output Mode b-01(02)	/	b-01	

● If there is no special requirement when purchase product, we choose 3# drain line flow control and 3# injector for the standard configuration.

Catalogue

Notice	3
1. Product Overview	4
1.1. Main Application & Applicability	4
1.2. Product Characteristics	4
1.3. Service Condition	7
1.4. Product Structure and Technical Parameters	8
1.5. Installation	9
2. Basic Setting & Usage	13
2.1. The Function of PC Board	13
2.2. Basic Setting & Usage	14
3. Applications.....	18
3.1. Flow Chart.....	18
3.2. The Function and Connection of PC Board	20
A. Signal Output Connector	21
B. Interlock	24
C. Pressure Relief Connector	24
D. Remote Handling Connector	25
E. Interlock System	25
F. Series System	25
3.3. System Configuration and Flow Rate Curve	26
3.4. Parameter Settlement	28
3.5. Parameter Enquiry and Setting	29
3.6. Trial Running	33
3.7. Trouble-shooting.....	34
3.8. Assembly & Parts	38
4. Warranty Card	41

Notice

- To ensure normal operation of the valve, please consult with professional installation or repairing personnel before using it.
- If there is any of pipeline engineering and electric works, there must be finished by professional at the time of installation.
- Do not use the control valve with the water that is unsafe or unknown quality.
- Depending on the changing of working environment and water requirement, each parameter of softener should be adjusted accordingly.
- When the water treatment capacity is too low, please check the resin. If the reason is shortage of resin, please add; if the resin turns to reddish brown or broken, please replace.
- Test water periodically to verify that system is performing satisfactorily.
- Ensure that there is solid salt all the time in the brine tank in the course of using, when this valve is used for softening. The brine tank should be added the crystalline coarse salt only, at least 99.5% pure, forbidding use the small salt.
- Do not put the valve near the hot resource, high humidity, corrosive, intense magnetic field or intense vibrations environment. And do not leave it outside.
- Forbidden to carry the injector body. Avoid using injector body as support to carry the system.
- Forbidden to use the brine tube or other connectors as support to carry the system.
- Please use this product under the water temperature between 5~50℃ water pressure 0.2~0.6MPa. Failure to use this product under such conditions voids the warranty.
- If the water pressure exceeds 0.6MPa, a pressure reducing valve must be installed before the water inlet. While, if the water pressure under 0.2MPa, a booster pump must be installed before the water inlet.
- It is suggested to install PPR pipe, corrugated pipe or UPVC pipe, instead of TTLSG pipe. Keep the pipeline straight.
- Do not let children touch or play, because careless operations may cause the procedure changed.
- When the attached cables or transformer of this product are broken, they must be changed to the one that is from our factory.
- We advise you to use M88×2 distributors. It is easy for disassembly.
- At the end of the product lifetime, parts and components of the product are sorted and properly disposed in accordance with local laws and regulations.

1. Product Overview

1.1. Main Application & Applicability

Used for softening, demineralization or filtration water treatment systems.

N77A (Down-flow regeneration), suitable for Ion exchange equipment, the raw water hardness $\leq 6.5\text{mmol/L}$.

Boiler softening water system.

RO pretreatment softening system, etc.

N77B (Filtration), suitable for swimming pool filter system.

Filtration system

Activated carbon filter or sand filter of RO pretreatment system.

1.2. Product Characteristics

●Simple structure and reliable sealing

It adopts hermetic head faces with high degree pottery and corrosion resistance for opening and closing. It combines with Service, Backwash, Brine & Slow Rinse, Brine Refill and Fast Rinse.

●Two ways for installation

Use side-mounted connector to change the valve from top-mounted installation to side-mounted installation. Screen is moveable.

●No water passes the valve during regeneration in single tank type

●Brine refill is controlled by electronic ball valve.

Brine refill is controlled by electronic ball valve, refilled when in service, shorten the regeneration time.

●For filtration system

Drain outlet is the same size as water outlet. Blocking the brine line connector, it can change the valve to N77B filter valve.

●Manual function

Realize regeneration immediately by pressing  at any time.



●Long outage indicator

If outage overrides 3 days, the time of day indicator  will flash to remind people to reset new time of day. The other set parameters do not need to reset. The process will continue to work after power on.

●LED dynamic screen display

The stripe on dynamic screen flash, it indicates the control valve is in service, otherwise, it is in regeneration cycle.

●Buttons lock

No operations to buttons on the controller within 1 minute, button lock indicator lights on which represent buttons are locked. Before operation, press and hold both  and  buttons for 5 seconds to unlock. This function can avoid incorrect operation.

●It can choose time clock type or meter type by program selection

Through the switch in control board (Application refers to figure on P20 to realize time clock type by day or by hour and meter type. (Attention: after adjust the switch, the valve should be cut off the power then connect again. Meter type valve have one more flow meter and probe wire than time clock type valve.)

●Interlock function

It has a function of interlock to realize only one valve in regeneration but other valves are in service while several valves are parallel in system. In multi-steps treatment systems such as RO pre-treatment, when several valves are in series, there is only one valve in regeneration or washing to ensure pass water all the times. (Application refer to Figure 3-9)

●Signal output

There is a signal output connector on main control board. It is for controlling external wiring (Refer to figures from Figure 3-1 to Figure 3-8).

There are two kinds of output modes: b-01 Mode: Turn on start of regeneration and shut off at the end of regeneration; b-02 Mode: Signal is available only at intervals of each status. Refer to below figure:

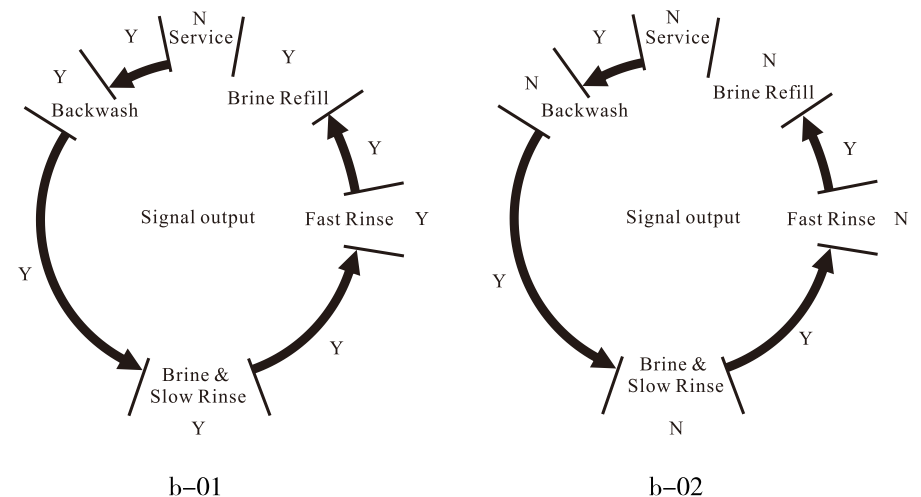

●Remote handling connector

This connector can receive external signal, used together with PLC, and computer etc. to control the valve. (Application refer to Figure 3-11)

●Pressure relief connector

The valve will cut off feeding water to drain line when it switches in regeneration cycles (Same as signal output b-02). Thus in some water treatment system, e.g. Deep Well, one booster pump was installed on the inlet to increase the system water feeding pressure, this cut-off will cause pressure on inlet rising too fast to damage the valve. Pressure Relief Connector can be used to avoid this problem. (Application refer to Figure 3-10)

●All parameters can be modified

According to the water quality and usage, the parameters in the process can be adjusted.

●Four kinds of meter type can be selected (suit for N77A3)

Model	Name	Instruction
A-01	Meter Delayed	Regenerate on the day although the available volume of treated water drops to zero (0). Regeneration starts at the regeneration time.
A-02	Meter Immediate	Regenerate immediately when the available volume of treated water drops to zero (0).
A-03	Intelligent Meter Delayed	Meter Delayed Regeneration type, but by setting resin volume, feed water hardness, regeneration factor, the controller will automatically calculate the water treatment capacity. Regeneration mode is the same as A-01.
A-04	Intelligent Meter Immediate	Meter Immediate Regeneration Type, but by setting resin volume, feed water hardness, regeneration factor, the controller will automatically calculate the water treatment capacity. Regeneration mode is the same as A-02.

●Maximum interval regeneration days (Suit for N77A3)

Under the situation of service reaching the setting days and the volume not yet, it could enter into regeneration process forcibly when current time is the same as regeneration time.

1.3. Service Condition

Runxin Valve should be used under the below conditions:

Items		Requirement
Working conditions	Water pressure	0.2MPa ~ 0.6MPa
	Water temperature	5°C ~ 50°C
Working environment	Environment temperature	5°C ~ 50°C
	Relative humidity	≤95% (25°C)
	Electrical facility	AC100 ~ 240V/50 ~ 60Hz
Inlet water quality	Water turbidity	Softener (N77A)<5FTU; Filter(N77B)<20FTU
	Water hardness	First Grade Na ⁺ <6.5mmol/L; Second Grade Na ⁺ <10mmol/L
	Free chlorine	<0.1mg/L
	Iron ²⁺	<0.3mg/L
	CODMn	<2mg/L (O ₂)

In the above table, First Grade Na⁺ represents First Grade Na⁺ Exchanger. Second Grade Na⁺ represents Second Grade Na⁺ Exchanger.

- When the water turbidity exceeds the conditions, a filter or coagulation or sediment should be added on the inlet of control valve.
- When the water hardness exceeds the conditions, the outlet water hardness will hardly reach the requirement of boiler feed water (≤0.03 mmol/L). It is suggested to adopt second grade softener.

MODEL: 63518-N77A1/63618-N77A3/53518-N77B1

1.4. Product Structure and Technical Parameters

A. Product dimension (The appearance is just for reference. It is subjected to the real product.)

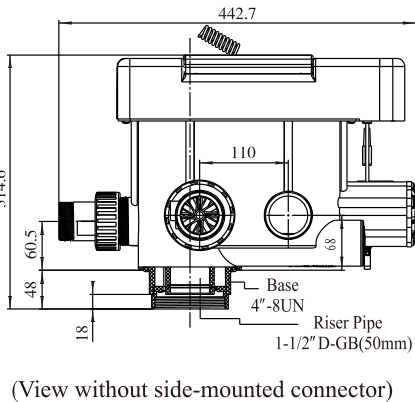
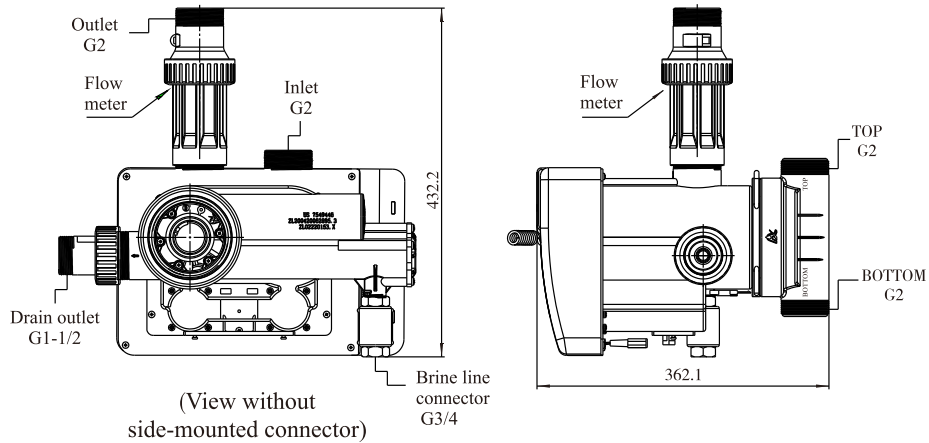

Remove the flow meter from N77A3, it will be N77A1. If remove the flow meter from N77A3 and block the drain line connector by blind nut (8940004), it will be N77B.

MODEL: 63518-N77A1/63618-N77A3/53518-N77B1

B. Technical Parameter

Transformer Output: DC24V/1.5A

Model	Connector Size					Flow Rate m ³ /h @0.3MPa	Remark
	Inlet/ Outlet	Drain Outlet	Brine Line Connector	Base	Riser Pipe		
N77A1	2" M	1.5" M	3/4" M	4-8UN	1.5"D-GB (50mm) or 1.9"OD (48.3mm)	18	DF softener, by day
N77A3							DF softener, meter type
N77B1	2" M	2" M	/	4-8UN		18	Filter, by day

Remark: M—Male F—Female OD—Outer Diameter

1.5. Installation

A. Installation notice

Before installation, read all those instructions completely. Then obtain all materials and tools needed for installation.

The installation of product, pipes and circuits, should be accomplished by professional to ensure the product can operate normally.

Perform installation according to the relative pipeline regulations and the specification of Water Inlet, Water Outlet, Drain Outlet, and Brine Line Connector.

B. Device location

- ①The filter or softener should be located close to drain.
- ②Ensure the unit is installed in enough space for operating and maintenance.
- ③Brine tank need to be close to softener.
- ④The unit should be kept away from the heater, and not be exposed to outdoor. Sunshine or rain will cause the system damage.
- ⑤Please avoid installing the system in the Acid/Alkaline, Magnetic or strong vibration circumstance, because above factors will cause the system disorder.
- ⑥Do not install the filter or softener, drain pipeline in circumstance which temperature may drop below 5°C, or above 50°C.
- ⑦Install the system in the place where with the minimum loss in case of water leaking.

C. Pipeline installation (Take N77A top-mounted as a sample)

① Install control valve

a. As the Figure 1-1 shows, select the riser pipe with 50mm OD, glue the riser pipe to the bottom strainer and put it into the resin tank, cut off the exceeding tube out of tank top opening and rounding. Plug the riser tube in case of resin entering.

b. Fill the resin to the tank, and the height is accordance with the design code.

c. Insert the top strainer to the valve.

d. Insert the riser pipe into control valve and screw tightly control valve.

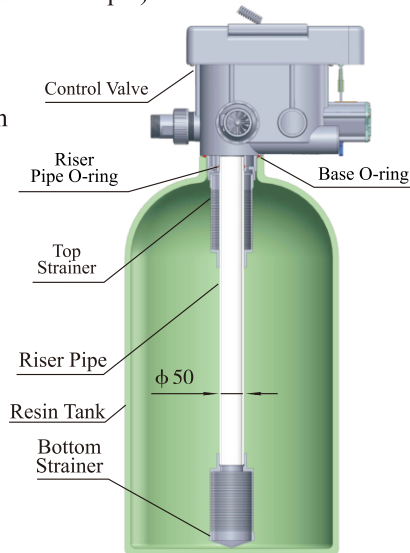

Figure 1-1

Note:

- The length of riser pipe should be neither higher 2mm nor lower 5mm tank top opening height and its top end should be rounded to avoid damage of O-ring inside the valve.
- Avoid filling floccules substance together with resin to the resin tank.
- Avoid O-ring inside control valve falling out while rotating it on the tank.

② Install flow meter

As Figure 1-2 shows, put the sealing ring into nut of flow meter, screw in water outlet; insert the probe wire into flow meter.

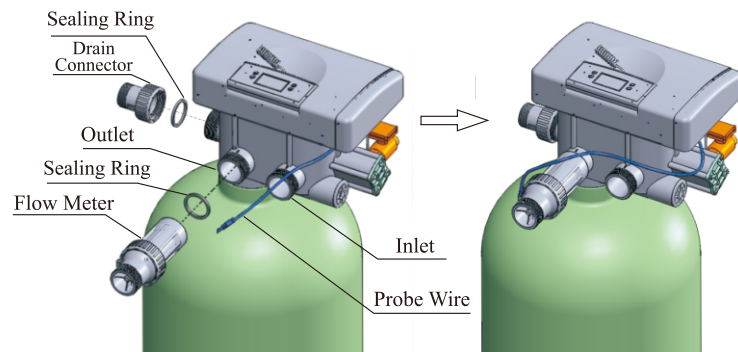

Figure 1-2

③ Pipeline connection

a. As Figure 1-3 shows, install a pressure gauge in water inlet.

b. Install valves A, B, C, D in inlet, outlet and pipeline. Valve D is a sampling valve.

c. Inlet pipeline should be in parallel with outlet pipeline. Support inlet and outlet pipeline with fixed holder.

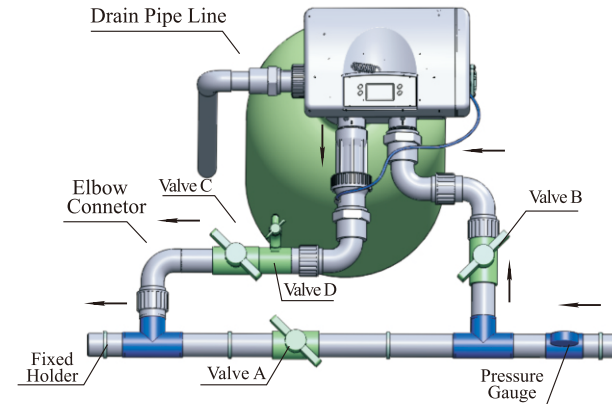

Figure 1-3

Note:

- If making a soldered copper installation, do all sweat soldering before connecting pipes to the valve. Torch heat will damage plastic parts.
- When turning threaded pipe fittings onto plastic fitting, use care not to cross thread or broken valve.
- If the valve is time clock type (N77A1, N77B1), there are no step ②.

④ Install drain pipeline (If no special requirement, the standard DLFC is suitable for 7703 injector)

a. Based on the table on P26, for N77A, if tank diameter is 900 mm, install according to step d and use the matched DLFC. If the tank size bigger than 900mm, users need to ask supplier for another DLFC which doesn't drill hole. Install it as below steps.

b. According to matched tank diameter size, drill φ 6 holes on the corresponding quantity of DLFC according to the requirement on P27.

c. Insert drain line flow control into drain hose connector, then crew it into drain outlet, and lock it.



Figure 1-4

d. Glue the drain outlet with DN40 UPVC pipe. Put drain outlet pipe to sewer as showed in the Figure 1-4.

e. For filter valve N77B, there is no DLFC, install DN50 UPVC pipe according to step d.

Note:

- Control valve should be higher than drain outlet, and be better not far from the drain hose.
- Be sure not connect drain with sewer, and leave a certain space between them, avoid wastewater being absorbed to the water treatment equipment, such as showed in the Figure 1-4.

⑤ Connect brine tube

a. As Figure 1-5 shows, use DN20 UPVC pipe to connect brine valve with brine line connector.

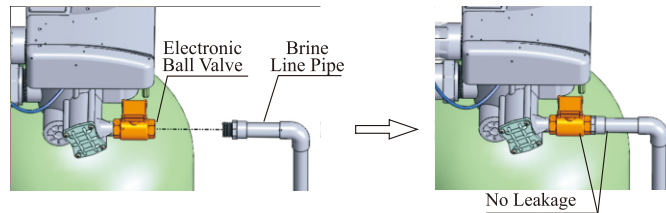

Figure 1-5

Note:



- Keep brine line shortly and smoothly. Quantity of elbows should no more than four pieces so as to avoid bad brine draw.
- Brine valve must be installed.

2. Basic Setting & Usage

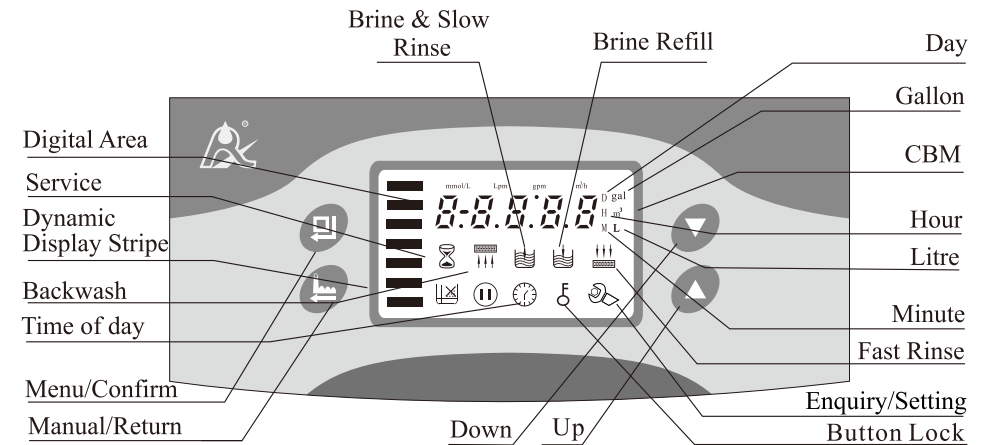
2.1. The Function of PC Board



- A. ⌚ Time of day indicator
- ⌚ Lights on, display the time of day.
- B. 🔒 Button lock indicator
- 🔒 Lights on, indicating the buttons are locked. At this moment, press any single button will not work (No operation in one minute, 🔒 will light on and lock the buttons.)
 - Solution: Press and hold both ⏴ and ⏵ for 5 seconds until the 🔒 lights off.
- C. 🔄 Program mode indicator
- 🔄 Lights on: enter program display mode. Use ⏴ or ⏵ to view all values.
 - 🔄 Flashes, enter program set mode. Press ⏴ or ⏵ to adjust values.
- D. 🗑️ Menu/Confirm button
- Press 🗑️, 🔄 lights on, enter program display mode and use ⏴ or ⏵ to view all values.
 - In program display mode, press 🗑️, 🔄 flashes, enter program set mode, press ⏴ or ⏵ and adjust values.
 - Press 🗑️ after all program are set, and then the voice “Di” means all setting are success and return program display mode.
- E. 🏠 Manual/Return button
- Press 🏠 in any status, it can proceed to next step. (Example: Press 🏠 in Service status, it will start regeneration cycles instantly; Press 🏠 while it is in Backwash status, it will end backwash and go to Brine & Slow Rinse at once.)

• Press  in program display mode, and it will return in Service; Press  in program set mode, and it will return program display mode.

• Press  while adjusting the value, then it will return program display mode directly without saving value.

F. Down  and Up 



• In program display mode, press  or  to view all values.





• In program set mode, press  or  to adjust values

• Press and hold both  and  for 5 seconds to unlock the buttons.

2.2. Basic Setting & Usage

A. Parameter specification

Function	Indicator	Factory Default	Parameter set range	Instruction
Time of Day		Random	00:00~23:59	Set the time of day when use; “:” flashes.
Control Mode	A-01	A-01	A-01	Regenerate on the day although the available volume of treated water drops to zero (0). Regeneration starts at the regeneration time.
			A-02	Regenerate immediate when the available volume of treated water drops to zero (0).
			A-03	Intelligent Meter Delayed Regeneration type, but by setting Resin Volume, Feed Water Hardness, Regeneration Factor, the controller will calculate the System Capacity. Regeneration mode same as A-01.
			A-04	Intelligent Meter Immediately Regeneration Type, but by setting Resin Volume, Feed Water Hardness, Regeneration Factor, the controller will calculate the System Capacity. Regeneration mode same as A-02.
Service Days		1-03D.	0 ~ 99 Days	Only for Time Clock Type, regeneration by day;
Service Hours		1-20H.	0 ~ 99 Hours	Only for Time Clock Type, regeneration by hour;
Regeneration Time	02:00	02:00	00:00~23:59	Regeneration time; “:” lights on.
Resin Volume	50L	500L	20~999L.	Resin volume in resin tank (L)
Feed Water Hardness	Yd1.2	1.2	0.1 ~ 9.9	Feed water hardness (mmol/L)

Exchange Factor	AL.65	0.65	0.30 ~ 0.99	Relate to the raw water hardness. When hardness is higher, the factor is smaller.
Water Treatment Capacity		80m ³	0 ~ 999.9m ³	Water treatment capacity in one cycle (m ³)
Backwash Time		10min.	0 ~ 99	Backwash time (Minute)
Brine & Slow Rinse Time		60min.	0 ~ 99	Brine & Slow rinse time (Minute)
Fast Rinse Time		10min.	0 ~ 99	Fast rinse time (Minute)
Brine Refill Time		5min.	0 ~ 99	Brine refill time (Minute)
Maximum Interval Regeneration Days	H-30	30	0 ~ 40	Regenerate on the day even though the available volume of treated water does not drop to zero (0).
Output Control Mode	b-01	01	01 or 02	b-01: Signal will turn on during the regeneration (Refer to the Figure on P5) b-02: Signal is only available at intervals of regeneration cycles and in service. (Refer to the Figure on P5)

B. Process Display

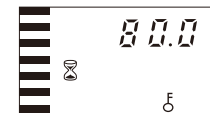

Figure A



Figure B



Figure C

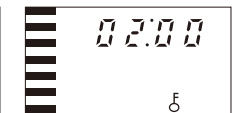

Figure D

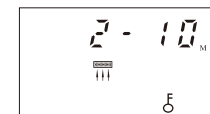

Figure E



Figure F

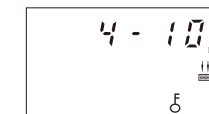

Figure G

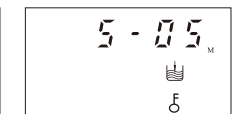

Figure H

Illustration

• In Service status, the figure shows A/B/C/D; In Backwash status, it shows figure E/C; In Brine & Slow Rinse status, it shows F/C; In Fast Rinse status, it shows figure G/C; In Brine Refill status, it shows figure H/C. In each status, every figure shows 15 seconds.

• Above displays are taking the Meter Type for example. For the Time Clock Type, it shows the rest days or hours, such as 1-03D or 1-10H.

• The display screen will only show “-00-” when the electrical motor is running.

MODEL: 63518-N77A1/63618-N77A3/53518-N77B1

- The time of day figure “🕒” flashes continuously, such as “12:12” flashes, indicates long outage of power. It reminds to reset the time of day.
- The display will show the error code, such as “-E1-” when the system is in error.
- Working process: Service→ Backwash→ Brine & Slow Rinse→ Fast Rinse → Brine Refill→ Service.

C.Usage

After being accomplished installation, parameter setting and trial running, the valve could be put into use. In order to ensure the quality of outlet water can reach the requirement, the user should complete the below works:

- ① Ensure that there is solid salt all the time in the brine tank in the course of using when this valve is used for softening. The brine tank should be added the crystalline coarse salt only, at least 99.5% pure, forbidding use the small salt and iodized salt.
- ② Test the outlet water and raw water hardness at regular time. When the outlet water hardness is unqualified, please press the 🏠 after unlock, and the valve will temporarily regenerate again (It will not affect the original set operation cycle.)
- ③ When the feed water hardness changes a lot, you can adjust the water treatment capacity as follow:

Press and hold both ⏴ and ⏵ for 5 seconds to unlock buttons. Press 🏠, and 🔄 lights on, then press ⏴, the digital area show the control mode. If it shows A-01 or A-02, press ⏴ three times, and the digital area will show the given water treatment capacity (If the control mode shows A-03 or A-04, then press ⏴ four times, the digital area will show the feed water hardness); Press 🏠 again, 🔄 and digital number flash. Press ⏴ or ⏵ continuously, reset the capacity value (Or water hardness). Press 🏠 and hear a sound “Di”, then finish the adjustment. Press 🏠 exit and turn back the service status.

The estimation of water treatment capacity, you can refer to the professional application specification. When select A-03 or A-04 intelligent control mode, the controller will automatically calculate the water treatment capacity by setting resin volume, feed water hardness and regeneration factor.

- ④ For A-01 or A-03 control mode (Delayed regeneration type), please pay attention to whether it is current time or not. If the time is not right, you can adjust as follow: After unlock buttons, press 🏠, the 🔄 and 🕒 light on. Then press 🏠, the 🔄 and hour value flashes. Press ⏴ or ⏵ continuously, reset the hour value; Press 🏠 again, 🔄 and minute value flash. Press ⏴ or ⏵ continuously, reset the minute value; Press 🏠 and hear a sound “Di”, then finish the adjustment. Press 🏠 exit and turn back the service status.

MODEL: 63518-N77A1/63618-N77A3/53518-N77B1

The regeneration parameters have been set when control valve left factory. Generally, it does not need to reset. If you want enquiry and modify the setting, you can refer to the professional application specification.

3. Applications

3.1. Flow Chart

For filter valve only has service, backwash and fast rinse.

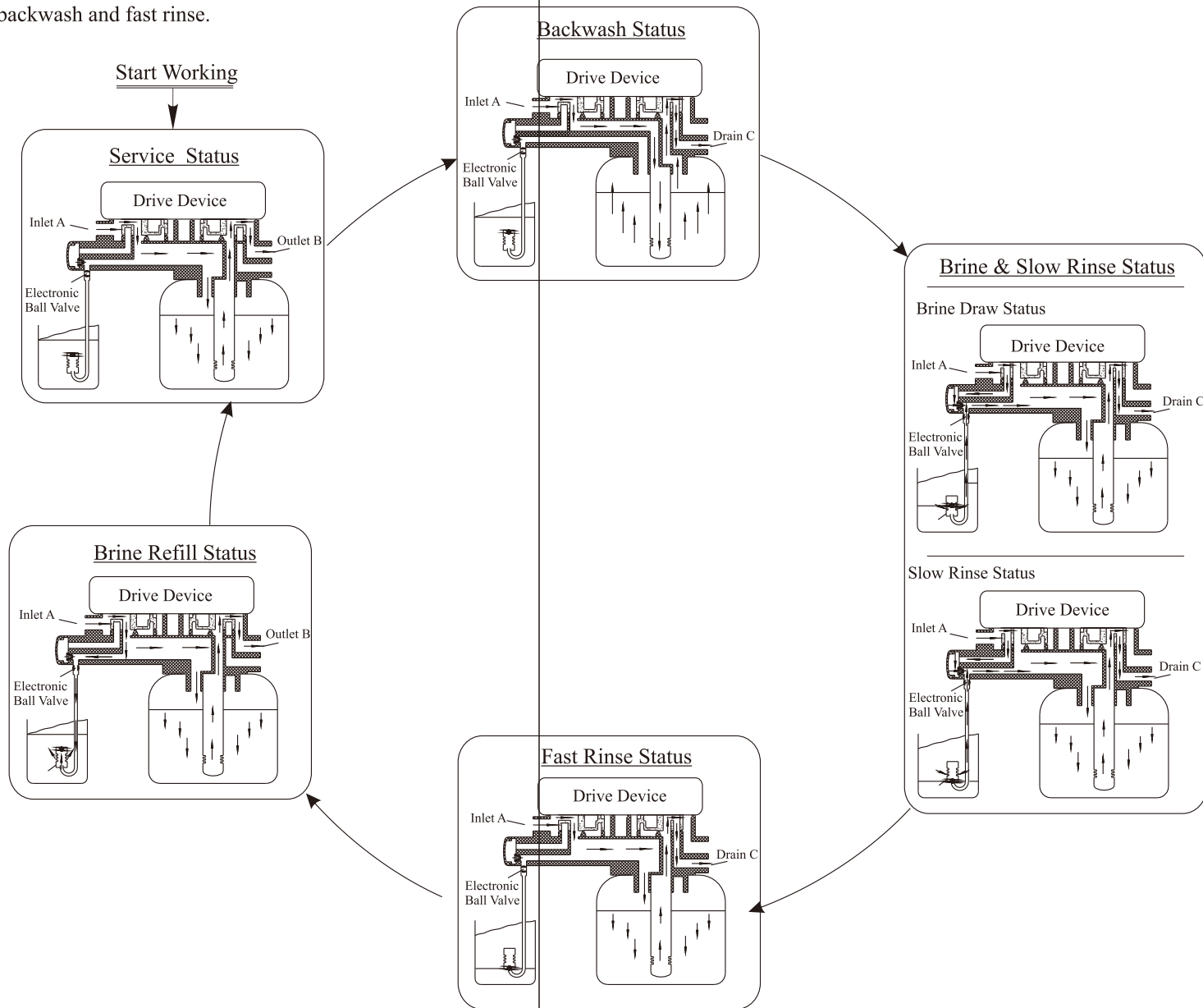

3.2. The Function and Connection of PC Board

Open the front cover of control valve, you will see the main control board and connection port as below:

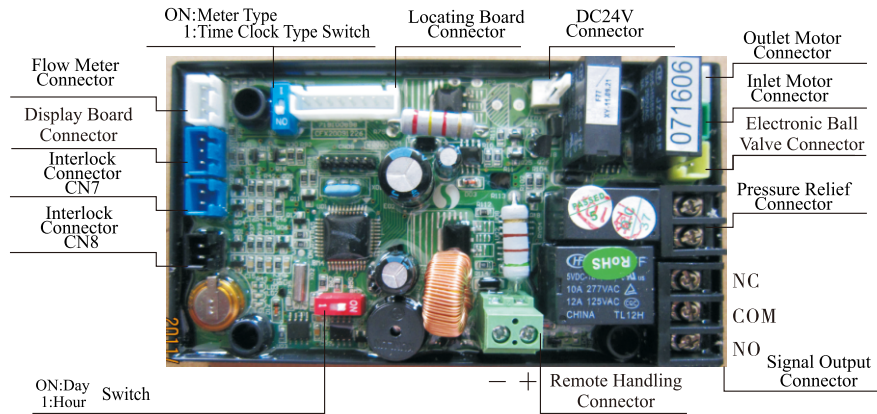

Functions on PC board:

Function	Application	Explanation
Signal output connector b-01	Outlet solenoid valve	Used in strict requirements regarding no hard water flowing from outlet or controlling the liquid level in water tank.
	Inlet pump	Increase pressure for regeneration or washing. Use the liquid level controller to control inlet pump to ensure there is water in tank.
Signal output connector b-02	Inlet solenoid valve or inlet pump	When inlet pressure is high, it needs to close water to protect motor when valve is rotating.
Pressure relief connector	Control the inlet bypass to release pressure	When valve is rotating, pressure relief connector opened to prevent pressure increasing rapidly.
Interlock connector	To ensure only one control valve regenerate or wash in system.	Use in RO Pre-treatment, water supply together but regeneration in turn. Second grade ion exchange equipment, etc.
Remote handling connector	Receive signal to make the control valve rotate to next step.	It is used for on-line inspection system, connected with PC to realize automatically or remotely control valve.

A. Signal Output Connector

1) Control Solenoid Valve (Set b-01)

① Solenoid valve on outlet controls water level in water tank.

Instruction: If system strictly requires no hard water flowing from outlet in regeneration cycle (mainly for no hard water flow out when valve is switching or valve in backwash or brine drawing positions), a solenoid valve could be installed on outlet, the wiring refer to Figure 3-1.

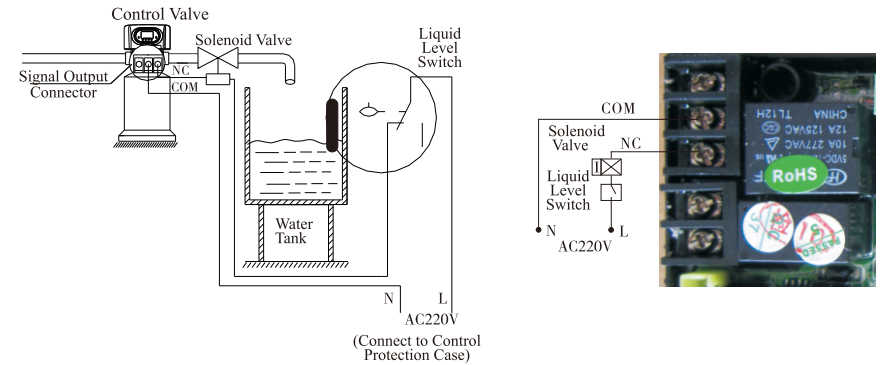

Figure 3-1 Wiring of Solenoid Valve on Outlet

Function:

When valve is in service status, if soft water tank is short of water, solenoid valve is open to supply soft water, but if water tank has enough water, solenoid valve is closed, so no soft water is supplied to tank.

When the valve is in backwash status, there is no signal output. So, solenoid valve is closed, and no water flows into soft water tank.

② Solenoid valve on inlet (Set b-02)

Instruction: When inlet pressure exceeds 0.6MPa, install a solenoid valve on inlet. Control mode is b-02. Pressure is relieved when valve switching, the wiring refers to Figure 3-2. As Figure 3-3 shows, it also can use the pressure relief connector to work.

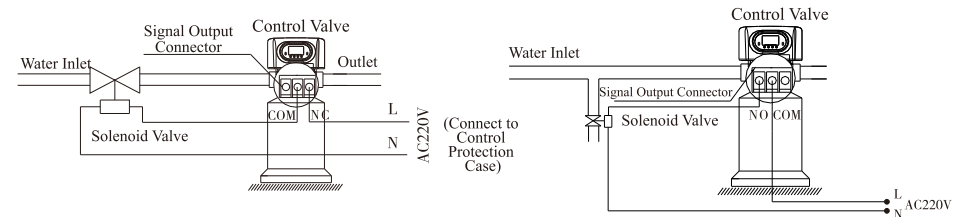

Figure 3-2 Wiring of Solenoid Valve on Inlet

Figure 3-3 Wiring of Pressure Relief Port

Instruction:

When inlet pressure is high, install a solenoid valve on inlet to ensure valve switches properly. The solenoid valve will open when valve is exactly at status of Service, Backwash, Brine& Slow Rinse, Brine Refill and Fast Rinse. When valve is switching, solenoid valve is closed, no water flows into valve to ensure valve switching properly. It could prevent the problem of mix water and water hammer.

Use interlock cable to realize valves in parallel and series in same system which is suited for RO pretreatment system or second grade Na⁺ system. The Wiring refers to Figure 3-4:

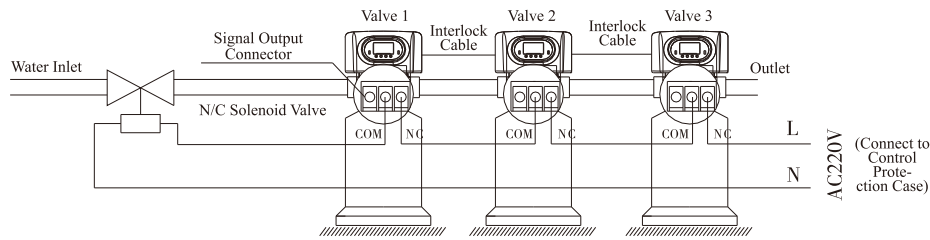

Figure 3-4 Wiring of Solenoid Valve in Inlet

2) Liquid Level Controller controls Inlet Pump (Two-phase motor) (Set b-01)

Instruction: For the system using well or middle-tank supplying water, users can turn on and turn off the pump by operating the switch of liquid level controller and control valve. The wiring refers to Figure 3-5:

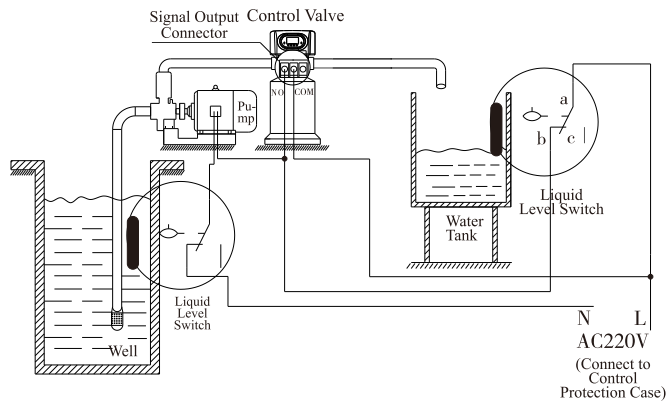

Figure 3-5 Wiring of Liquid Level Controller Controlling 220V Inlet Pump

Function:

When valve is in service status, if water tank is short of water, pump starts working, but if water tank has enough water, the switch of liquid level controller is closed, so pump doesn't work.

When valve is in regeneration cycle, inlet always has water no matter what is water condition in water tank. As for Runxin valve, no water passing outlet in regeneration cycle, which ensures no water fill into brine tank. A liquid switch at the top opening well or in middle water tank in RO system protects pump from working without water in case of out of raw water.

3) Liquid Level Switch in Water Tank Controls Inlet pump (Three-phase, as Figure 3-6) (Set b-01)

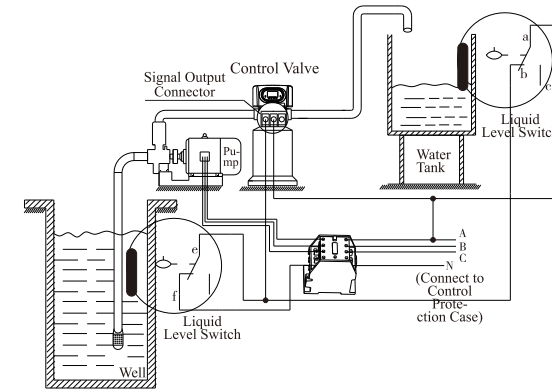

Figure 3-6 Wiring of Liquid Level Switch in Water Tank Controls 380V Inlet Pump

4) Control Inlet Booster Pump (Set b-01 or b-02)

Instruction: If inlet water pressure is less than 0.15MPa, which makes backwash or brine drawing difficult, a booster pump is suggested to be installed on inlet. Control mode b-01. When system in regeneration cycle, booster pump opens, the wiring refer to Figure 3-7. If the booster pump current is bigger than 5A, system need to install an contactor, the wiring refer to Figure 3-8.

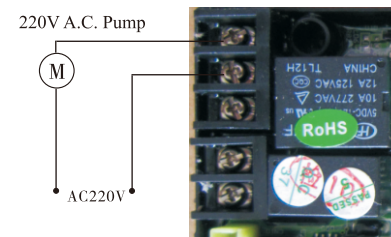

Figure 3-7 Wiring of Booster Pump on Inlet

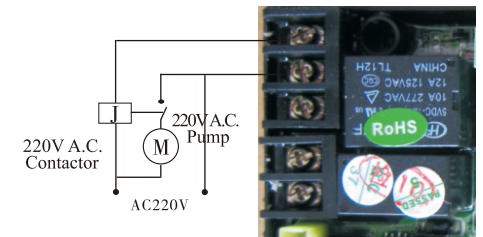

Figure 3-8 Wiring of Booster Pump on Inlet

B. Interlock

Instruction: In the parallel water treatment system, it ensures only one valve in regeneration or washing cycle and (n-1) valves in service, that is, realizing the function of supplying water simultaneously and regenerating individually.

In the series water treatment system which is suited for RO pretreatment system or second grade Na⁺ system, it ensures only one valve in regeneration or washing cycle and every grade has water when in regeneration or washing. Wiring refers to Figure 3-9:

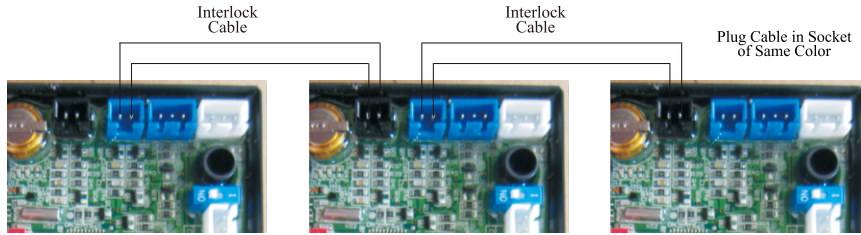

Figure 3-9 Network System Wiring with Interlock Cable

Note: Use interlock cable to connect the black socket of one valve with the blue socket of another valve in series.

One system with several valves, if interlock cable is disconnected, the system is divided into two individual system.

C. Pressure Relief Connector

Runxin valve will cut off feeding water to drain line when it switches in regeneration cycles. Thus in some water treatment system, e.g. Deep Well, one booster pump was installed on the inlet to increase the system water feeding pressure, this cut-off will cause pressure on inlet rising too fast to damage the valve. Pressure Relief Connector can be used to avoid this problem. The wiring refers to Figure 3-10:

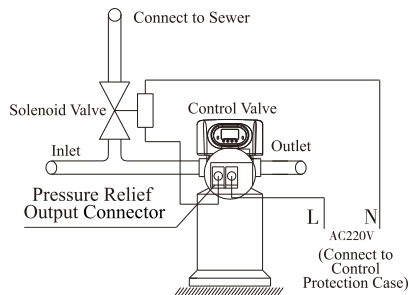

Figure 3-10 Wiring of Pressure Relief Connector

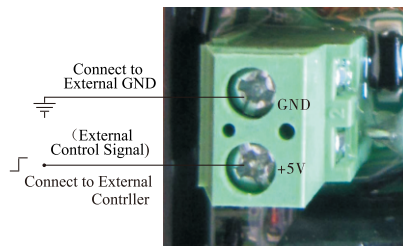

Figure 3-10 Wiring of Remote Handling Connector

D. Remote Handling Connector

When the valve is used to make pure water or other system that can be monitored online or connected to a PC, etc., when the conductivity or other parameters reach the set value or the PC sends a signal and needs system regeneration, it can provide a signal to remote handling connector of main control board by the signal line, which can make the valve regenerate immediately. The connector receiving the signal is equivalent to pressing the manual button. The wiring refers to Figure 3-11:

E. Interlock System

2 or more than 2 valves are interlocked connecting in one system and all valves are in service but regenerate individually. The wiring refers to Figure 3-12.

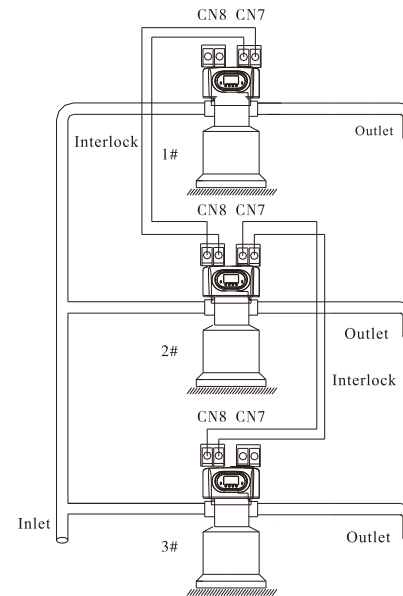

Figure 3-12 Interlock system

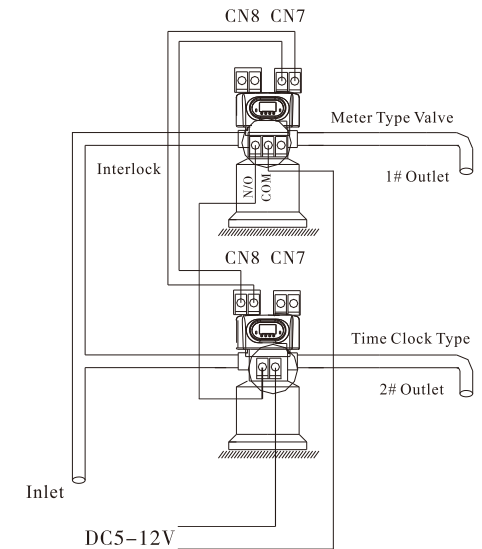

Figure 3-13 Series system

F. Series System

This is a 2 or more than 2 valves system, all in service, with one flow meter for the entire system. For the time type valve, the regeneration time should be set and adjusted to the Max; for the volume type valve, connect its signal output connector with the remote handle connector of the time-type valve. That can realize the function of supplying water simultaneously and regenerating orderly. The wiring refers to Figure 3-13:

3.3. System Configuration and Flow Rate Curve

A. Product Configuration

Product configuration with tank, resin volume, brine tank and injector.

Tank Size (mm)	Resin Volume (L)	Flow Rate (t/h)	Brine Tank Size (mm)	The Minimum Salt Consumption for Regeneration (Kg)	Injector Model
φ 750 × 1800	450	11.0	φ 840 × 1335	67.50	7702
φ 900 × 2400	900	16.0	φ 1080 × 1460	135.00	7703
φ 1000 × 2400	1100	20.0	φ 1240 × 1575	165.00	7704

Attention: The flow rate calculation is based on linear velocity 25m/h; the minimum salt consumption for regeneration calculation is based on salt consumption 150g/L (Resin).

B. Flow Rate Characteristic

1) Pressure-flow Rate Curve

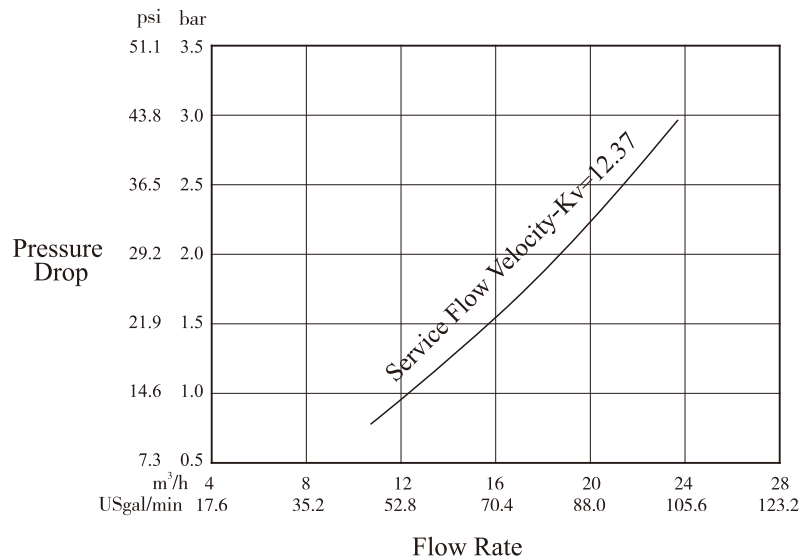

2). Injector parameter table

Inlet Pressure	Draw Rate (L/M)				
	7701 Coffee	7702 Pink	7703 Yellow	7704 Blue	7705 White
0.20 MPa	18.72	25.83	35.52	42.27	49.25
0.25	26.83	32.42	45.59	57.02	63.58
0.30	32.08	39.41	51.16	64.90	72.37
0.35	37.56	49.79	59.17	70.75	79.85
0.40	42.14	54.77	63.77	76.46	85.86

3) Configuration for Standard Injector and Drain Line Flow Control

Tank Dia. mm	Injector Model	Injector Color	Draw Rate	Slow Rinse	DLFC & Holes Quantity	Backwash Fast Rinse
			L/m	L/m		L/h
700	7701	Coffee	32	20	0	7.5
750	7702	Pink	39.5	26.5	0	7.5
800	7702	Pink	39.5	26.5	1 × φ 6	9.2
850	7703	Yellow	51.2	33.3	1 × φ 6	9.2
900	7703	Yellow	51.2	33.3	2 × φ 6	10.2
1000	7704	Blue	64.9	42	3 × φ 6	11.2
1050	7705	White	72.4	48.7	4 × φ 6	13

Remark:

- Above data for the product configuration and relevant characteristics are only for reference. When put in practice, please subject to the different requirements of raw water hardness and application.
- Above parameter is tested under 0.3MPa inlet pressure.
- Holes quantity is the holes number on DLFC. Diameter of hole is φ6, the number refers to above table.

3.4. Parameter Settlement

① Service time T1

Water treatment capacity:

$$Q = V_R \times K \div Y_D \text{ (m}^3\text{)}$$

- Hardness of inlet water (mmol/L)
- Exchange factor (mmol/L) 400~1000. Down-flow regeneration, take 400~750. Up-flow regeneration, take 450~1000. If the inlet water hardness is higher, the factor is smaller.
- Resin volume (m³)

By hours: $T1 = Q \div Q_h \text{ (Hour)}$

- Average water consumption per hour (m³/h)
- Water treatment capacity (m³)

By days: $T1 = Q \div Q_d \text{ (Day)}$

- Average water consumption per day (m³/d)
- Water treatment capacity (m³)

② Backwash time T2

It is subject to the turbidity of inlet water. Generally, It is suggested to be set 10~15 minutes. The higher the turbidity is, the longer backwash time can be set. However, if the turbidity is more than 5FTU, it should be better to install a filter in front of the exchanger.

③ Brine & slow rinse time T3

$$T3 = (40 \sim 50) \times H_R \text{ (min.)}$$

Generally, $T3 = 45H_R \text{ (min.)}$

In this formula, H_R —The height of resin in exchange tank (m.)

④ Brine refill time T4

Down-flow regeneration: $T4 = 0.45 \times V_R \div \text{Brine refill speed (min.)}$

Up-flow regeneration: $T4 = 0.34 \times V_R \div \text{Brine refill speed (min.)}$

In this formula, V_R — Resin volume (m³)

The Brine refill speed is related to inlet water pressure. It is suggested to lengthen 1~2 minutes of calculated brine refilling time to make sure there is enough water in tank. (The condition is that there is a level controller installed in the brine tank.)

⑤ Fast rinse time T5

$$T5 = 12 \times H_R \text{ (min.)}$$

Generally, the water for fast rinse is 3~6 times of resin volume. It is suggested to be set 10~16 minutes, but subject to the outlet water reaching the requirement.

⑥ Exchange factor

$$\text{Exchange factor} = E / (k \times 1000)$$

In this formula, E—Resin working exchange capability (mol/m³), it is related to the quality of resin. Down-flow regeneration, take 800~900. Up-flow regeneration, take 900~1200.

K—Security factor, always take 1.2~2. It is related to the hardness of inlet water: the higher the hardness is, the bigger the K is.

⑦ Regeneration time

The whole cycle for generation is about two hours. Please try to set up the regeneration time when you don't need water according to the actual situation.

The calculation of parameters for each step is only for reference, the actual proper time will be determined after adjusting by water exchanger supplier. This calculation procedure of softener is only for industrial application; it is not suitable for small softener in residential application.



3.5. Parameter Enquiry and Setting

3.5.1. Parameter Enquiry

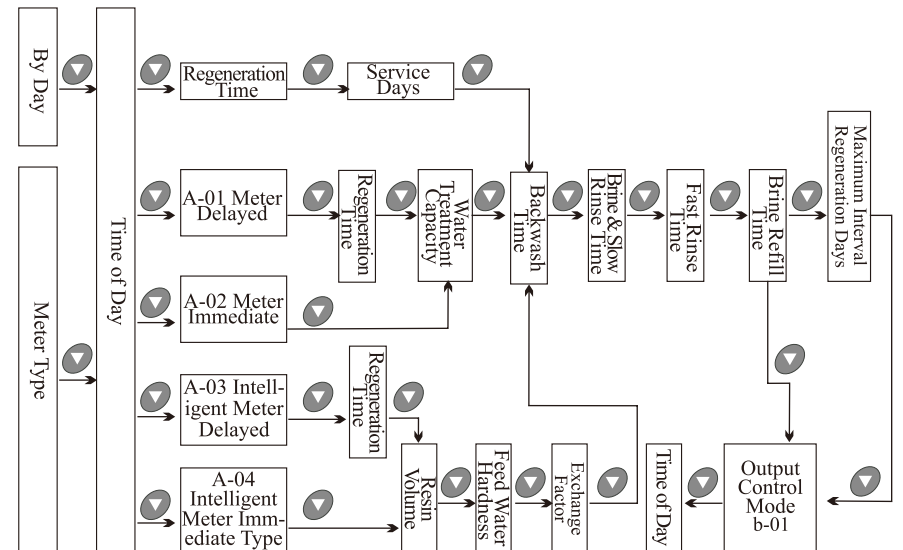





































When lights on, press and hold both and for 5 seconds to unlock buttons; then press and lights on, enter to program display mode; press or to view each value according to below process. (Press exit and turn back to service status).









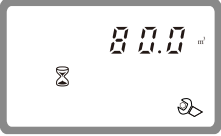





















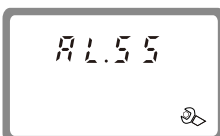

























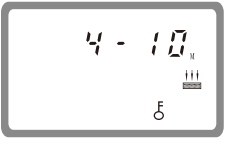











3.5.2.Parameter Setting

In program display mode, press  and enter into program set mode. Press  or  to adjust the value.













3.5.3.The steps of parameter setting

Items	Process steps	Symbol
Time of Day	<p>When time of day “12:12” continuously flashes, it reminds to reset;</p> <p>1. Press  to enter into program display mode; both  and  symbol light on, “:” flashes; Press , both  and hour value flash, through  or  to adjust the hour value;</p> <p>2. Press  again, both  and minute value flash, through  or  to adjust the minute value;</p> <p>3. Press  and hear a sound “Di”, then finish adjustment, press  to turn back.</p>	
Control Mode	<p>1. In control mode display status, press  and enter into program set mode,  and 01 value flash;</p> <p>2. Press  or , set the value to be A-01, A-02, A-03 or A-04 control mode</p> <p>3. Press  and hear a sound “Di”, then finish adjustment, press  to turn back.</p>	
Regeneration Time	<p>1. In regeneration time display status, press  and enter into program set mode.  and 02 flash;</p> <p>Press  or  to adjust the hour value;</p> <p>2. Press  again,  and 00 flash, press  or  to adjust the minute value;</p> <p>3. Press  and hear a sound “Di”, then finish adjustment, press  to turn back.</p>	
Water Treatment Capacity	<p>1. In water treatment capacity display status, it shows  and 80.0. Press  and enter into program set mode.  and 80.0 flash;</p> <p>2. Press  or  to adjust the water treatment capacity value (m³);</p> <p>3. Press  and hear a sound “Di”, then finish adjustment, press  to turn back.</p>	

Resin Volume	<p>1. In resin volume display status, it shows 100L. Press  and enters into program set mode.  and 100 value flash;</p> <p>2. Press  or  to adjust the volume value(L);</p> <p>3. Press  and hear a sound “Di”, then finish adjustment, press  to turn back.</p>	
Feed Water Hardness	<p>1. In feed water hardness display status, it shows yd1.2. Press  and enter into program set mode.  and 1.2 value flash;</p> <p>2. Press  or  to adjust the volume value (mmol/L);</p> <p>3. Press  and hear a sound “Di”, then finish adjustment, press  to turn back.</p>	
Exchange Factor	<p>1. In exchange factor display status, it shows AL.55. Press  and enter into program set mode.  and 55 flash;</p> <p>2. Press  or  to adjust the exchange factor value;</p> <p>3. Press  and hear a sound “Di” then finish adjustment, press  to turn back.</p>	
Backwash Time	<p>1. In backwash time display status, it shows  and 2-10. Press  and enter into program set mode.  and 10 flash;</p> <p>2. Press  or  to adjust the backwash time;</p> <p>3. Press  and hear a sound “Di” then finish adjustment, press  to turn back.</p>	
Brine & Slow Rinse Time	<p>1. In brine& slow rinse time display status, it shows  and 3-60. Press  and enter into program set mode.  and 60 flash;</p> <p>2. Press  or  to adjust the brine time (minute);</p> <p>3. Press  and hear a sound “Di”, then finish adjustment, press  to turn back.</p>	

Fast Rinse Time	<p>1. In fast rinse time display status, it shows  and 4-10. Press  and enter into program set mode.  and 10 flash;</p> <p>2. Press  or  to adjust the fast rinse time (minute);</p> <p>3. Press  and hear a sound “Di”, then finish adjustment, press  to turn back.</p>	
Brine Refill Time	<p>1. In brine refill time display status, it shows  and 5-05. Press  and enter into program set mode.  and 05 flash;</p> <p>2. Press  or  to modify the brine refill time;</p> <p>3. Press  and hear a sound “Di”, then finish adjustment, press  to turn back.</p>	
Maximum Interval Regeneration Days	<p>1. In maximum Interval regeneration days display status, it shows H-30. Press  and enter into program set mode.  and 30 flash;</p> <p>2. Press  or  to adjust the Interval regeneration days (day);</p> <p>3. Press  and hear a sound “Di”, then finish adjustment, press  to turn back.</p>	
Signal Output Mode	<p>1. In signal output mode display status, it shows b-01. Press  and enter into program set mode.  and 01 flash;</p> <p>2. Press  or  to adjust the b-02;</p> <p>3. Press  and hear a sound “Di”, then finish adjustment, press  to turn back.</p>	

For example, the fast rinse time of a softener is 12 minutes. After regenerating, the chloridion in the outlet water is always higher than normal, indicating that there is not enough time for fast rinse. If you want the time to set to 15 minutes, the modification steps as follows:

- ① Press and hold both  and  to unlock buttons ( lights off);
- ② Press , and  lights on;
- ③ Press  or  continuously until  lights on. Then the digital area shows: 4-12M;
- ④ Press ,  and 12 flash;
- ⑤ Press  continuously until 12 is changed to 15;
- ⑥ Press , there is a sound “Di” and the figure stop flashing; the program back to enquiry status;



⑦ If you want to adjust other parameters, you can repeat the steps from ② to ⑤; If you don't, press  and quit from the enquiry status, the display will show the current service status.



3.6. Trial Running



After installing the multi-functional flow control valve on the resin tank with the connected pipes, as well as setting up the relevant parameter, please conduct the trial running as follows:



A. Close the inlet valve B & C, and open the bypass valve A. After cleaning the foreign materials in the pipe, close the bypass valve A. (as Figure 1-3 shows)



B. Fill the brine tank with the planned amount of water and adjust the air check valve. Then add solid salt to the tank and dissolve the salt as much as possible.

C. Switch on power. Press  and go in the Backwash position; when  lights on, slowly open the inlet valve B to 1/4 position, making the water flows into the resin tank; you can hear the sound of air-out from the drain pipeline. After all air is out of pipeline, then open inlet valve B completely and clean the foreign materials in the resin tank until the outlet water is clean. It will take 8~10 minutes to finish the whole process.

D. Press , turning the position from Backwash to Brine& Slow Rinse;  lights on and enter in the process of Brine& Slow Rinse. The air check valve closes when control valve finishing brine drawing, then turns to slow rinse. It is about 60~65 minutes for whole process.

E. Press  to Fast rinse position.  lights on. It takes about 10~15 minutes, take out some outlet water for testing: if the water hardness reaches the requirement, and the chloridion in the water is almost the same compared with the inlet water, then go to the next step.

F. Press  to Brine refill position.  lights on and it indicates the brine tank is being refilled with water to the required level. It takes about 5~6 minutes, then add solid salt to the brine tank.

G. Press , making the control valve return to Service Status;  lights on and starts to running.

Note:

● When the control valve enters into the regeneration status, all program can be finished automatically according to the setting time; if you want one of steps to be terminated earlier, you can press .

● If water inflows too fast, the media in tank will be damaged. When water inflows slowly, there is a sound of air emptying from drain pipeline.

● After changing resin, please empty air in the resin according to the above Step C.

● In the process of trial running, please check the water situation in all position, ensuring there is no resin leakage.

●The time for Backwash, Brine& Slow Rinse, Brine Refill and Fast Rinse position can be set and executed according to the calculation in the formula or suggestions from the control valve suppliers.

3.7. Trouble-Shooting

A. Control Valve Fault

Problem	Cause	Correction
1. Softener fails to regenerate.	A. Electrical service to unit has been interrupted. B. Regeneration cycles set incorrectly. C. Controller is defective. D. Motor fails to work.	A. Assure permanent electrical service (Check fuse, plug, pull chain or switch). B. Reset regeneration cycles. C. Replace controller. D. Replace motor.
2. Regeneration time is not correct.	A. Time of Day does not set correctly. B. Power failure more than 3 days.	A. Check program and reset time of day. B. Reset time of day.
3. Softener supply hard water.	A. Bypass valve is open or leaking. B. No salt in brine tank. C. Injector is plugged. D. Insufficient water flows into brine tank. E. Leak at O-ring on riser pipe. F. Internal valve leaks. G. Regeneration cycles not correct or raw water get worse. H. Shortage of resin. I. Bad quality of feed water or turbine is blocked.	A. Close or repair bypass valve. B. Make sure there is salt in brine tank. C. Change or clean injector. D. Check brine tank refill time. E. Make sure riser pipe and o-ring is not cracked. F. Change valve body. G. Set correct regeneration time or water treatment capacity. H. Add resin to resin tank and check why resin leaks. I. Reduce the inlet turbidity, clean or replace turbine.
4. Softener fails to draw brine.	A. Inlet water pressure is too low. B. Brine line is plugged. C. Brine line is leaking. D. Injector is plugged. E. Internal control leaks. F. Drain line is plugged. G. Sizes of injector and DLFC does not match with tank. H. Ball valve or cable is damaged.	A. Increase inlet water pressure. B. Clean brine line. C. Replace brine line. D. Clean or replace new injectors. E. Replace valve body. F. Clean drain pipeline. G. Select correct injector and DLFC according to the manual requirements. H. Replace ball valve or cable

Control Valve Fault

5. Unit uses too much salt.	A. Improper salt setting. B. Excessive water in brine tank.	A. Check salt usage and salt setting. B. See the solutions for problem no.6.
6. Excessive water in brine tank.	A. Overlong brine refilling time. B. Remain too much water after brine draw. C. Foreign material in brine valve. D. Power outage when brine drawing and system without liquid level controller. E. Brine refill is out of control. F. Ball valve doesn't close.	A. Reset correct refilling time. B. Check the injector and make sure no stuff in the brine pipe. C. Clean brine valve and brine line. D. Stop water supplying and restart or install liquid level controller in brine tank. E. Repair or replace liquid level controller. F. Close or replace ball valve.
7. Pressure lost or rust in the pipe.	A. Iron scale in the water supply pipe. B. Iron scale accumulated in the softener. C. Fouled resin bed. D. Too much iron in the raw water.	A. Clean the water supply pipe. B. Clean valve and add resin cleaning chemical, increase frequency of regeneration. C. Check backwash, brine draw and brine refill. Increase frequency of regeneration and backwash time. D. Iron removal equipment is required to install before softening.
8. Resin discharged through drain pipe.	A. Air in water system. B. Strainer is broken. C. Backwash flow rate is too high.	A. Exhaust air existed in system. B. Replace new strainer. C. Check for proper drain flow rate.
9. Control valve cycle continuously.	A. Locating signal wiring breaks down. B. Controller is faulty. C. Foreign material stuck the driving gear. D. Time of regeneration steps were set to zero.	A. Check and connect locating signal wiring. B. Replace controller. C. Take out foreign material. D. Check and reset program setting
10. Drain flows continuously.	A. Internal valve leaks. B. Power off when valve is in backwash or fast rinse status.	A. Check and repair valve body or replace it. B. Adjust valve to service position or turn off bypass valve and restart after electricity supply is normal.
11. Interrupted or irregular brine.	A. Water pressure is too low or not stable. B. Injector is plugged or faulty. C. Air in resin tank. D. Floccules in resin tank during up-flow regeneration.	A. Increase water pressure. B. Clean or replace injector. C. Check and find the reason of air intake. D. Clean the floccules in resin tank.

Control Valve Fault

12. Water flows out from drain or brine pipe after regeneration.	A. Foreign material in valve which makes valve can't be closed completely. B. Hard water is mixed in valve body. C. Water pressure is too high which result in valve doesn't get the right position. D. Ball valve or cable failure.	A. Clean foreign material in valve body. B. Change valve core or sealing ring. C. Reduce water pressure or use pressure relief function. D. Repair or replace ball valve or cable.
13. Salt water in soften water.	A. Foreign material in injector or injector fails to work. B. Brine valve cannot be shut-off. C. Time of fast rinse is too short.	A. Clean and repair injector. B. Repair brine valve and clean it. C. Extend fast rinse time.
14. Water capacity decreases.	A. Unit fails to regenerate or does not regenerate properly. B. Resin is fouled or bad. C. Salt consumption is not proper. D. Softener setting is not proper. E. Raw water quality deterioration. F. Turbine of flow meter is stuck.	A. Regenerate according to the correct operation requirement. B. Increase backwash flow rate and time, clean or change resin. C. Readjust salt consumption. D. According to the test of outlet water, recount and reset. E. Regenerate unit manually, then reset regeneration cycle. F. Disassemble flow meter and clean it or replace a new flow meter.

B. Controller Fault

Problem	Cause	Correction
1. All indicators display on front panel.	A. Wiring of display board with control board fails to work. B. Control board is faulty. C. Transformer is damaged. D. Electrical service is not stable.	A. Check and replace the wiring. B. Replace control board. C. Check and replace transformer. D. Check and adjust electrical service.
2. No display on front panel.	A. Wiring of display board with control board fails to work. B. Display board is damaged. C. Control board is damaged. D. Adapter is damaged.	A. Check and replace wiring. B. Replace display board. C. Replace control board. D. Check electricity.
3. E1 Flashes	A. Wiring of locating board with control board fails to work. B. Locating board is damaged. C. Mechanical driven failure. D. Faulty control board. E. Wiring of motor with control board is broken. F. Motor is damaged.	A. Replace wiring. B. Replace locating board. C. Check and repair mechanical part. D. Replace control board. E. Replace wiring of motor with control board.. F. Replace motor.
4. E2 Flashes	A. Hall component on locating board is damaged. B. Wiring of locating board with control board fails to work. C. Control board is faulty.	A. Replace locating board. B. Replace wiring. C. Replace control board.
5. E3 or E4 Flashes	A. Control board is faulty.	A. Replace control board.

3.8. Assembly & Parts

N77A3 (63618) Structure:

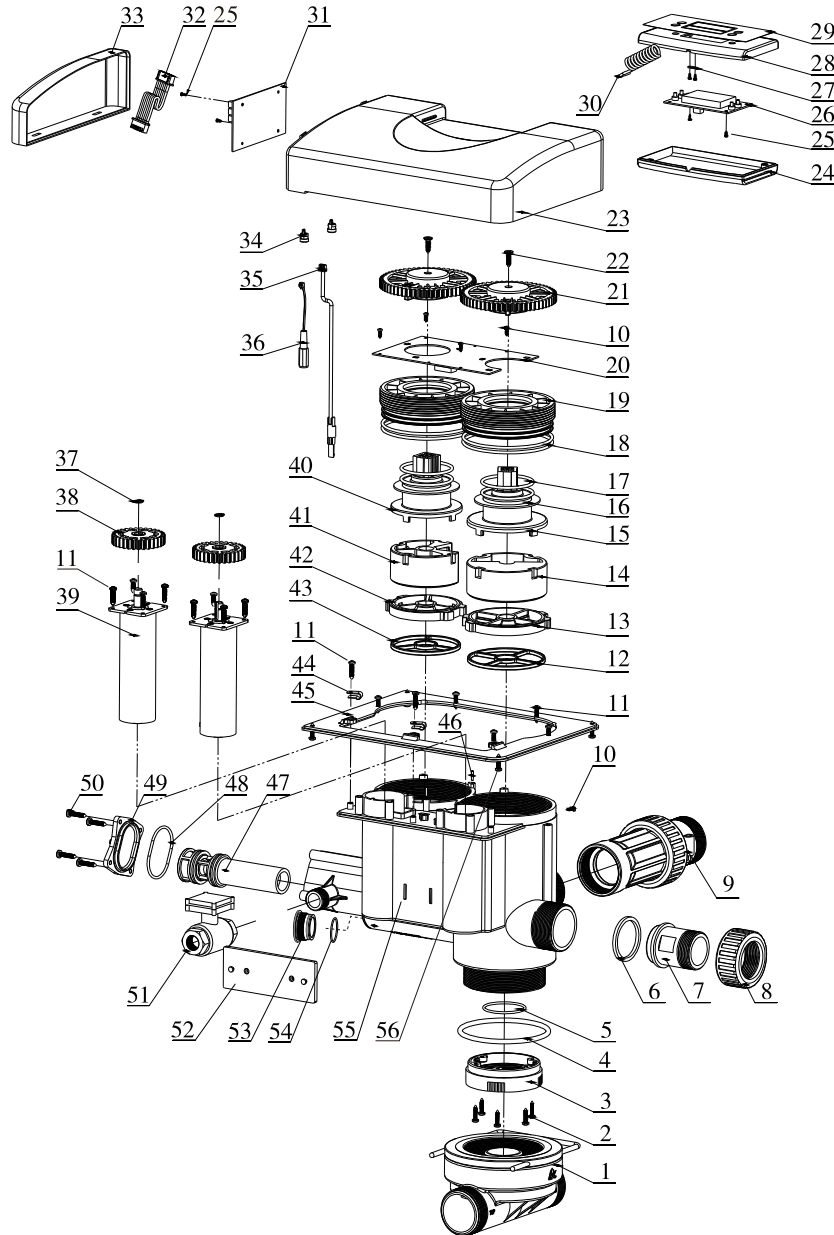

N77A1/N77A3 Valve Body Components (Item No. 9, 35 only for N77A3)

Item No.	Description	Part Number	Quantity	Item No.	Description	Part Number	Quantity
1	Side-mounted Connector	5458002	1	24	Board Back Cover	8315008	1
2	Screw, Cross ST3.9×19	8909003	5	25	Screw, Cross ST 2.2×6.5	8909004	4
3	Connector	8458018	1	26	Display Board	6381007	1
4	O-ring 104.6×5.7	8378146	1	27	Cable Clip	8126001	1
5	O-ring 50.47×2.62	8378308	1	28	Board Front Cover	8300013	1
6	Seal Ring	8371008	1	29	Sticker	8865011	1
7	Drain Line Flow Control	8468012	1	30	Three-core Spring	5517001	1
8	Animated Connector	8947005	1	31	Control Board	6382030	1
9	Flow Meter	5447003	1	32	Wire for Locating Board	5511006	1
10	Screw, Cross ST2.9×9.5	8909008	14	33	Front Cover	8300012	1
11	Screw, Cross ST3.9×16	8909044	16	34	Wire Clip	8126004	2
12	Seal Ring	8370044	1	35	Probe Wire	6386003	1
13	Fixed Disk	8469022	1	36	Wire for Power	5513004	1
14	Moving Disk	8459024	1	37	Pin	8994009	2
15	Shaft	8258005	1	38	Small Gear	5241008	2
16	Anti-friction Washer	8216006	2	39	Motor	6158036	2
17	O-ring 59.92×3.53	8378110	4	40	Shaft	8258012	1
18	O-ring 107.54×3.53	8378112	4	41	Moving Disk	8459023	1
19	Fitting Nut	8092009	2	42	Fixed Disk	8469021	1
20	Locating Board	6380017	1	43	Seal Ring	8370042	1
21	Gear	5241007	2	44	Cable Clip	8126002	2
22	Screw, Cross ST4.8×19	8909018	2	45	Junction Plate	8152009	1
23	Dust Cover	8005011	1	46	Pin 2.5×12	8993004	2

MODEL: 63518-N77A1/63618-N77A3/53518-N77B1

47	Injector	5468019	1	53	Plug	8323009	1
48	O-ring 52×3	8378096	1	54	O-ring 40×2.65	8378091	1
49	Injector Cover	8315007	1	55	Valve Body (GB-Standard)	5022073	1
50	Screw, Cross ST4.8×25	8909021	4		Valve Body (US-Standard)	5022073A	
51	3/4" Ball Valve	6922074	1	56	Screw, Cross ST3.9×16	8909016	4
52	Display Shelf	8040003	1				

For N77B, there are no item 6, 7, 8, 9, 35 and 51. But it has one more piece seal ring 8371019 and one piece blind nut 8940004.

5447003 Flow meter Structure:

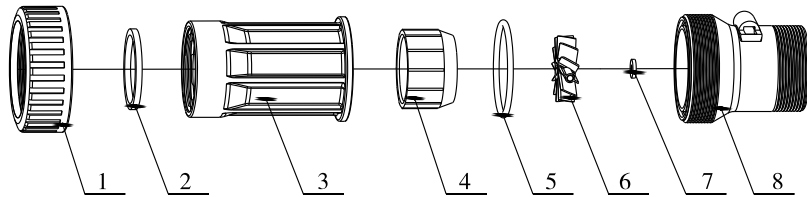

5447003 Flow Meter Components:

Item No.	Description	Part No	Quantity	Item No.	Description	Part No	Quantity
1	Animated Nut	8947004	1	5	O-ring 60×4	8378137	1
2	Seal Ring	8371008	1	6	Turbine	5436005	1
3	Connector	8458016	1	7	Bushing	8210002	1
4	Fixed Connector	8109006	1	8	Flow Meter Shell	5002002	1

5458002 Side-mounted Connector Structure:

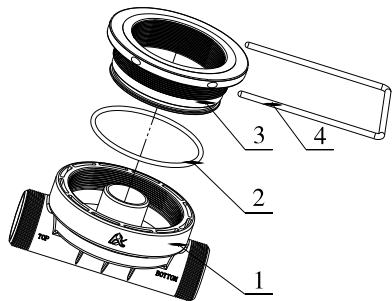

5458002 Side-mounted Connector Components:

Item No.	Description	Part No	Quantity
1	Connector	8458037	1
2	O-ring 110×4.5	8378140	1
3	Joint	8457017	1
4	Steel Fork	8271003	1

MODEL: 63518-N77A1/63618-N77A3/53518-N77B1

4. Warranty Card

Dear client:

This warranty card is the guarantee proof of multi-functional flow control valve. It is kept by client self. You could get the after-sales services from the supplier which is appointed by Runxin manufacturer. Please keep it properly. It couldn't be retrieved if lost.

It couldn't be repaired free of charge under the below conditions:

1. Guarantee period expired. (One year)
2. Damage resulting from using, maintenance, and keeping that are not in accordance with the instruction.
3. Damage resulting from repairing not by the appointed maintenance personnel.
4. Content in guarantee proof is unconfirmed with the label on the real good or be altered.
5. Damage resulting from force majeure.

Product Name	 Multi-functional Flow Control Valve for Water Treatment Systems		
Model		Code of Valve Body	
Purchase Company Name		Tel/Cel.	
Problem			
Solution			
Date of Repairing	Date of Accomplishment	Maintenance Man Signature	

When product needs warranty service, please fill in the below content and send this card together with the product to the appointed suppliers or Runxin company.

End-user Company Name		Tel/Cel.	
Purchase Company Name		Tel/Cel.	
Model	Code of Valve Body		
Tank Size ϕ ×	Resin Tank Size L	Raw Water Hardness mmol/L	
Water Source: Ground-water <input type="checkbox"/> Tap Water <input type="checkbox"/>	Water Treatment Capacity m ³	Backwash Time min	
Brine & Slow Rinse Time min	Brine Refill Time min	Fast Rinse Time min	
Problem Description			